



# MESSKO® MPreC® 试验台

# MESSKO® MPreC® TEST BENCH

## 使用说明书/Operating Instructions

BA 3451814/00 ZH-EN . MESSKO INSTRUMENTS



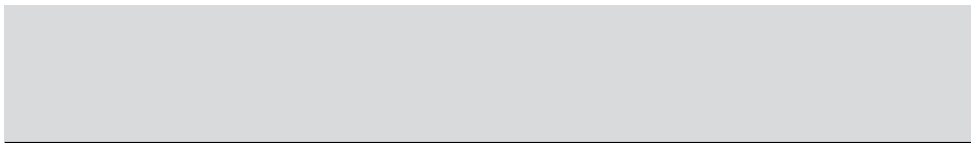



目录

1	安全	4
1.1	安全提示	4
1.2	按规定使用	4
1.3	设备操作提示	4
2	产品说明	5
2.1	供货范围	5
3	调试	6
4	运行	8
5	维护和服务	12
6	技术数据	14
7	附录	15
7.1	尺寸	15
7.2	测试证书	16

Contents

1	Safety	17
1.1	Safety notes	17
1.2	Intended use	17
1.3	Notes for operation of the device	17
2	Product description	18
2.1	Scope of supply	18
3	Commissioning	19
4	Operation	21
5	Maintenance and service	25
6	Technical data	27
7	Appendix	28
7.1	Dimensions	28
7.2	Test certificate	29

**!** 提示

本使用说明书中包含的信息可能与交付的设备稍有差异。

保留更改的权利。

**!** NOTE

Data contained herein may differ in details from the equipment delivered.

We reserve the right to make alterations without notice.



请妥善保管，以备将来参考！

Please keep this manual for future reference!

## 1 安全

### 1.1 安全提示

从事本设备的安装、调试和运行工作的所有人员必须

- 具有足够的专业资格，
- 严格遵守本使用说明书。

违章操作或错误使用可能导致

- 危及人身安全，
- 损坏本设备和用户的其它财产，
- 降低本设备的工作效率。

本使用说明书包括下列提示，以强调重要的注意事项。



### 注意

设备的安装、电气连接、调试和维护必须由合格的专业人员严格遵照本使用说明书来进行。

操作人员应保证按照规定使用本设备。

为安全起见，事先未经 MESSKO 的同意不得擅自以及违规进行安装、电气连接、调试和运行操作！



### 警告

表示针对人身安全的特殊危险。忽视该提示可能造成重伤或死亡。



### 注意

表示针对本设备或用户其它财产的危险。另外不排除可能危害人身安全。



### 提示

表示针对某具体事项的重要说明。

### 1.2 按规定使用

Messko® MPreC® 试验台测试并记录油浸式变压器上压力释放阀在拆卸状态下的准确性和功能安全性。

调试设备前，必须注意并遵守铭牌上和和使用说明书中规定的使用限值。

### 1.3 设备操作提示

用户必须遵守所在国家和地区的事故预防条例。

特别要注意的是，如果要操作的部件是带电部件，即接触其会产生危险的部件，必须将其断电或避免直接接触。

安装时必须遵守下列规定。

## 2 产品说明

MESSKO® MPreC® 试验台测试并记录油浸式变压器上压力释放阀在拆卸状态下的准确性和功能安全性。

移动试验台是用于调试、运行和维护变压器的检测设备。

 提示

MESSKO® MPreC® 试验台只适用于法兰有六个安装孔，且安装孔中心距为235mm的压力释放阀。

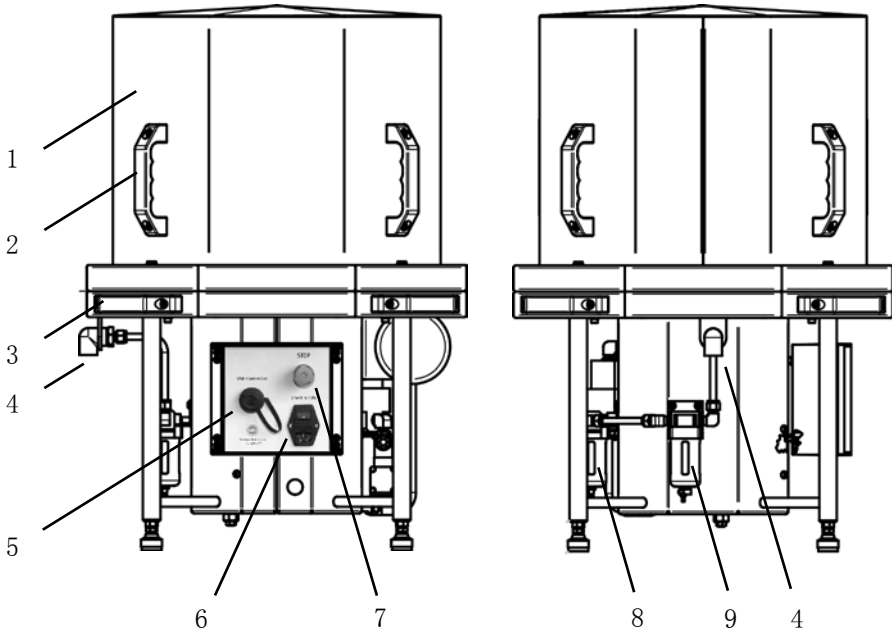

## 2.1 供货范围

- 1x MESSKO® MPreC® 试验台 (含保护罩)
- 1x MESSKO® MPreC® 试验台软件
- 1x USB 2.0 A 型到 B 型线缆
- 1x 使用说明书
- 1x 带 IEC 插头的电源线



- 1 保护罩
- 2 手柄 (保护罩上有 4 个)
- 3 手柄 (底部有 4 个)
- 4 压缩空气接口 G1/2 “
- 5 USB 接口
- 6 电源接口
- 7 急停按钮
- 8 主过滤器 (压缩空气)
- 9 预过滤器 (压缩空气)

## 3 调试

	说明	图
1	<p>请将 MPreC® 试验台放在平坦的水平面上。</p> <div data-bbox="174 384 568 539" style="border: 1px solid black; padding: 5px;"> <p> <b>警告</b></p> <p>请确保试验台底部稳定，不会滑动或倾斜。</p> </div> <div data-bbox="174 549 568 671" style="border: 1px solid black; padding: 5px;"> <p> <b>注意</b></p> <p>建议由两人或多人抬起试验台并将其放到正确位置（重量约为 50 kg）。</p> </div>	
2	<p>两个人从 MPreC® 试验台底部向上提起保护罩并将其放在安全的位置。</p> <div data-bbox="174 831 568 954" style="border: 1px solid black; padding: 5px;"> <p> <b>注意</b></p> <p>建议由两人从试验台底部抬起保护罩。</p> </div>	
3	<p>通过现有的 G1/2“ 接口连接压缩空气供应。</p> <div data-bbox="174 1075 568 1283" style="border: 1px solid black; padding: 5px;"> <p> <b>注意</b></p> <p>进给的压缩空气的压力必须在 4 bar 和 10 bar 之间。</p> <p>将压缩空气供应（压缩空气瓶、空气压缩机等）安全连接到现有压缩空气接口时，必须遵守所在国家或地区的规定。</p> </div> <div data-bbox="174 1292 568 1433" style="border: 1px solid black; padding: 5px;"> <p> <b>提示</b></p> <p>必须使用符合 ISO 8573-1:2001 (E) 质量等级 2.2.4（无尘、无油、无水）的干净的压缩空气。</p> </div>	 





	说明	图
4	<p>用随附的电源线连接电源并打开设备。</p> <div data-bbox="176 370 568 523" style="border: 1px solid black; padding: 5px; margin-top: 10px;">  <p><b>警告</b></p> <p>户外使用时，如有必要，请根据天气采取适当的保护。</p> </div>	
5	<p>通过 USB 接口和随附的 USB 线缆与您的 PC 或笔记本电脑之间建立数据连接。</p>	
6	<p>启动随附 CD 中的 MESSKO® MPreC® 试验台安装程序。要求的操作系统是含有 SP 3 的 Microsoft Windows XP 或更新的 MS Windows 版本。</p>	 <p style="text-align: center;">setup_MPreC_V1.0...</p>
7	<p>按照安装向导中的指导操作。</p>	
8	<p>如果安装成功，则可以通过创建的 MPreC 程序图标启动该软件。</p> <p>必要时可以通过“Uninstall MPreC”（卸载 MPreC）将其卸载。</p>	



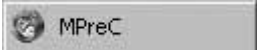
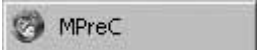

## 4 运行

	说明	图
1	<p>请取下要测试的压力释放阀的保护罩。</p> <div data-bbox="174 416 568 568" style="border: 1px solid black; padding: 5px; margin-top: 10px;"> <p><b>!</b> 提示</p> <p>确保压力释放阀的法兰，特别是安装密封件无脏污。</p> </div>	
2	<p>用 M12 螺栓和垫圈通过安装法兰上的 6 个孔将压力释放阀安装在试验台上。安装时必须在设备下方安装一个安装密封件。</p> <div data-bbox="174 834 568 963" style="border: 1px solid black; padding: 5px; margin-top: 10px;"> <p><b>!</b> 提示</p> <p>安装压力释放阀时请注意制造商的说明。</p> </div>	
3	<p>用六个 M12 螺栓和六个垫圈将压力释放阀拧紧在 MPreC 试验台的支承板上。</p> <div data-bbox="174 1145 568 1334" style="border: 1px solid black; padding: 5px; margin-top: 10px;"> <p><b>!</b> 注意</p> <p>请确保 M12 固定螺栓的长度不超过压力释放阀的法兰厚度再加 15 mm (紧固板螺栓长度)。</p> </div>	

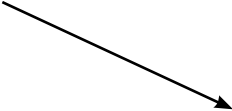

	说明	图
4	<p>两个人将保护罩放置在 MPreC 试验台上。 注意不要碰到压力释放阀的信号标杆。</p> <div data-bbox="173 386 568 510" style="border: 1px solid black; padding: 5px;"> <p> <b>注意</b> 建议由两人将保护罩放到试验台底部。</p> </div>	
6	<p>通过现有的 G1/2 “接口连接压缩空气供应。</p> <div data-bbox="173 598 568 813" style="border: 1px solid black; padding: 5px;"> <p> <b>注意</b> 进给的压缩空气的压力必须在 4 bar 和 10 bar 之间。 将压缩空气供应（压缩空气瓶、空气压缩机等）安全连接到现有压缩空气接口时，必须遵守所在国家或地区的规定。</p> </div>	  <div data-bbox="618 726 1019 890" style="border: 1px solid black; padding: 5px;"> <p> <b>提示</b> 必须使用符合 ISO 8573-1:2001 (E) 质量等级 2.2.4 (无尘、无油、无水) 的干净的压缩空气。</p> </div>
7	<p>用随附的电源线连接电源并打开设备。</p> <div data-bbox="173 992 568 1109" style="border: 1px solid black; padding: 5px;"> <p> <b>警告</b> 户外使用时，如有必要，请根据天气采取适当的保护。</p> </div>	 
8	<p>MPreC 试验台运行时，急停按钮中间的 LED 呈红色。</p> <div data-bbox="173 1200 568 1353" style="border: 1px solid black; padding: 5px;"> <p> <b>注意</b> 按此键可以在试验台开启后随时将其关闭。</p> </div>	 
9	<p>通过 USB 接口和随附的 USB 线缆与您的 PC 或笔记本电脑之间建立连接。</p>	

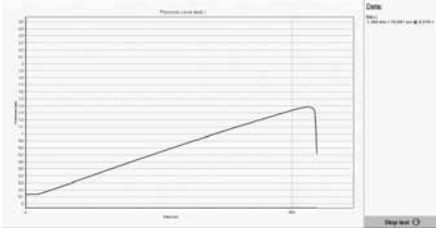
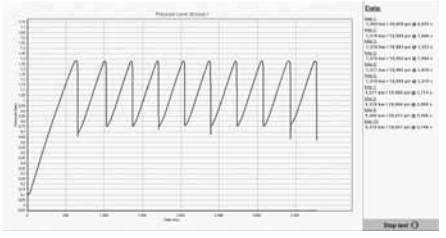
	<p>说明</p>	<p>图</p> 
<p>10</p>	<p>通过程序图标启动 MPreC 应用软件。</p>	
<p>11</p>	<p>选择用户界面的语言（英语或中文）。切换语言必须重新启动软件。</p>	
<p>12</p>	<p>通过“Settings”（设置）可以指定试验记录保存的格式（“PDF”和/或“Picture”）。</p> <p>在下方的输入行中可以指定保存路径。</p>	 <p>如果选择了“Export (autom.): enabled”（输出（自动）：启用），那么自动试验过程结束后，输出文件将自动保存至指定路径。</p>
<p>13</p>	<p>请在“Serial no.”（序列号）下输入压力释放阀的序列号（必填）。</p> <p>在“Additional text”（附加文本）下可以输入附加文本。</p> <p>请选择要试验的压力释放阀的压力范围。</p> <p>请选择试验次数（1、5 或 10）</p>	
<p>14</p>	<p>开始试验。</p> <div data-bbox="172 1222 568 1426" style="border: 1px solid black; padding: 5px;"> <p><b>⚠ 提示</b></p> <p>用鼠标点击程序按钮“Start test”（开始试验）后，试验过程自动启动，而且在释放压力释放阀进行压力补偿时发出较大噪声。</p> </div>	

	说明	图
15	试验结束后选择“Testresults”（试验结果），检查试验结果。 	
16	1 次测量试验的示例	
17	10 次测量试验的示例	
18	如果未选择“Export (autom.): enabled”（输出（自动）：启用）选择字段，那么试验结束后可以选择“PDF-Report”（PDF 报告）和“OK”将试验结果以 PDF 文件保存在指定路径下。  选择“Picture”（图片）和“OK”，试验记录将以图片文件格式（jpg）保存在指定路径下。然后将该文件导入或编辑为 Word 文件。  保存路径可以随时更改。	

5 维护和服务

MESSKO MPreC 移动试验台无需维护。







建议每 3 年更换或校准压力变送器。



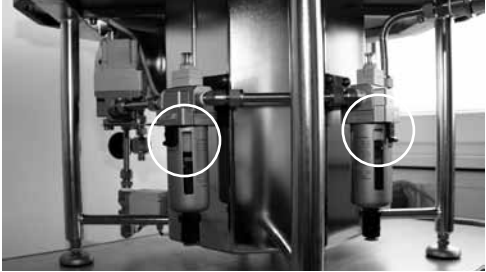

5.1 更换过滤器

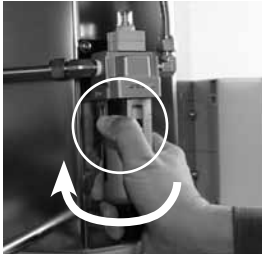

**注意**



更换过滤器前必须断开压缩空气供应。

	说明	图
1	<p>根据脏污程度更换主过滤器和/或预过滤器。</p> <p>主过滤器 </p> <p>预过滤器 </p>	 <p><b>提示</b> 脏污程度与使用周期和使用的压缩空气质量有关。</p>
2	<p>向下按预过滤器的锁。</p> 	
3	<p>将锁保持在当前位置并向左转动过滤器滤芯。</p> 	

	说明	图
4	<p>当标记 I (上) 和 II (下, 在滤芯上) 正对时, 向下拉出过滤器滤芯。</p> 	
5	<p>向左旋下过滤器。</p>	
6	<p>将过滤器从顶部和底部的黑色塑料部分拆下, 更换新的过滤器。 按相反顺序进行安装 (步骤 5、4、3 和 2)。</p> <p>制造商: SMC, 订购号 AF30P-060S</p> 	

5 维护和服务

6 技术数据

	说明	图
7	以同样的方法更换主过滤器。	
8	更换新的主过滤器芯子。 这里浅色的过滤器和顶部和底部的黑色塑料部分是一体的，要一起更换。  制造商：SMC 订购号 AFM30P-060AS	 
9	按相反顺序进行安装（步骤 5、4、3 和 2）。	

## 6 技术数据

外壳:

尺寸: 约 800 mm x 600 mm x 600 mm

重量: 约 50 kg

软件: MPreC® 压力释放阀试验

操作系统要求:

含有 SP 3 的 MS Windows XP

或

更新的 MS Windows 版本;

语言: 英语/中文;

测量周期: 1、5 或 10, 可调节

电源:

电源电压: 110/230V

电源频率: 50/60 Hz

功率消耗: 约 25 W

压缩空气供应:

压力: 4.0 bar 至 10 bar 之间

压缩空气质量: 符合 ISO 8573-1:2001 (E) 标准

2.2.4 等级 (无尘、无油、无水)。

压力测量值:

测量范围: 4 psi ... 30 psi

准确性: ±1 psi (4 psi 至 12 psi 范围)

±2 psi (15 psi 至 30 psi 范围)

接口:

USB: B 型 USB

运行条件:

防护等级: IP 55 (控制柜)

工作温度: -10° C ... +50° C

## 7.1 尺寸

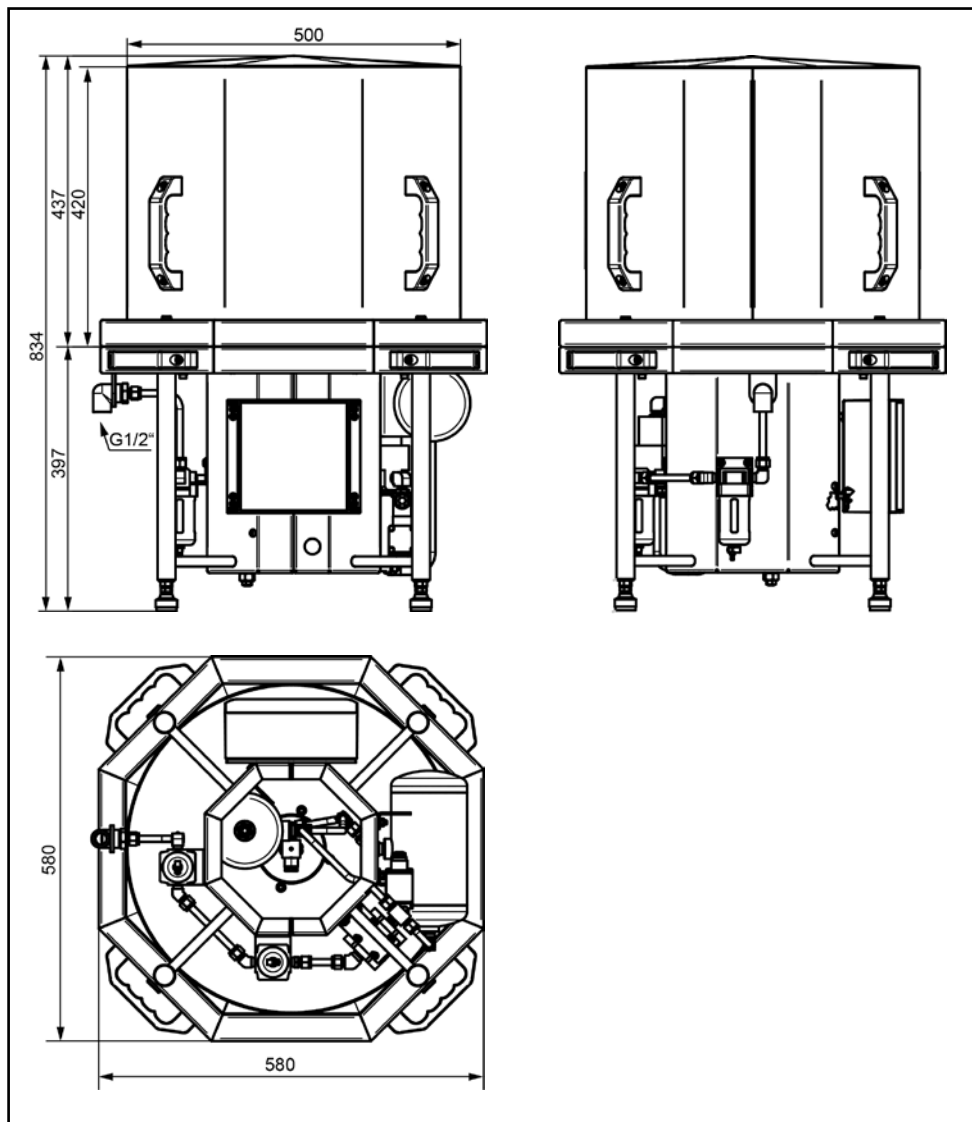



## 7.2 测试证书

DEKRA Automobil GmbH Suchskrug 5-7 24107 Kiel

Hightec Anlagenbau  
Inhaberin Gabriele Ziegler e. K.  
Vor dem Hassel 6  
21438 Brackel

DEKRA Automobil GmbH  
Industrie, Bau und Immobilien  
Außenstelle Kiel  
Suchskrug 5-7  
24107 Kiel  
Phone +49.431.200697-70  
Fax +49.431.200697-99

Contact:  
Dipl.-Ing. (FH) Lars Götsch  
Tel. direct +49.431.200697-72  
E-Mail lars.goetsch@dekra.com  
Date 06.05.2013

## Test Certificate

**Kind of test:** Check of documents, functional ad tightness test  
**Legal basis:** 97/23/EG; Art. 3, cl. 3  
**Tets location:** Hightec Anlagenbau  
Vor dem Hassel 6; D- 21438 Brackel

**Kind of pressure equipment:** Test facility for safety valves

<b>Data of construction:</b>	
Category acc. to PED 97/23/EG	Art. 3 cl. 3
Application	Test facility for control and testing of safety valves
Manufacturer	Hightec Anlagenbau, 21438 Brackel
Manufacturing No. / Code	78666200
Max. all. pressure PS	12 bar
Year of built	04.2013
Assembly / location	mobile test facility

<b>Test result:</b>	The test facility is due to the test results <input checked="" type="checkbox"/> suitable for the intended use. <input type="checkbox"/> not suitable
---------------------	--

**Remarks:**  
In the course of testing the a.m. test facility was checked in respect to function, tightness and assembly. Furthermore the assembly was compared and assessed with the available documentation. The documentation included drawings (No. 12-055-01-000), adjustment certificates as well as manufacturer documents of the used components.

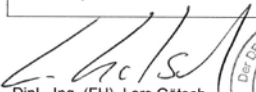
  
Dipl.-Ing. (FH) Lars Götsch  
Authorised Inspector Pressure Equipment



Stempel

DEKRA Automobil GmbH  
Handwerkerstraße 15  
D-70565 Stuttgart  
Telefon +49.711.7861-0  
Telefax +49.711.7861-2240  
www.dekra.com

Sitz Stuttgart, Amtsgericht Stuttgart,  
HRB-Nr. 21039  
Bankverbindung:  
Commerzbank AG  
(BLZ 600 600 00) Kto.-Nr. 9 010 051 00  
Landesbank Baden-Württemberg  
IBAN 25 12 05 100 00 00 00 00 00 00 00 00 00

Vorsitzender des Aufsichtsrates  
Stefan Kobi  
Geschäftsführer:  
Clemens Klinkle (Vorsitzender)  
Wolfgang Linsenmaier  
Dr. Gerd Neumann





## 1 Safety

### 1.1 Safety notes

All persons involved with the fitting, commissioning and operation of the device must be

- adequately professionally qualified and
- strictly observe these operating instructions.

In the event of improper operation or misuse, there is a threat to

- life and limb,
- the equipment and other property of the operator and
- the equipment's ability to function efficiently.

Notes are used in these operating instructions to emphasize important information.



### WARNING

indicates particular risks to life and limb. Failure to comply with these notes may lead to very serious injuries or death.



### CAUTION

indicates potential hazards for the device or other property belonging to the operator. It is also impossible to rule out risks to life and limb.



### NOTE

refers to important information on a specific topic.

### 1.2 Intended use

The Messko® MPreC® test bench tests and logs the accuracy and functional safety of pressure relief valves on oil-filled transformers in the disassembled state.

It is imperative in use to observe and comply with the limit values shown on the rating plate and specified in the operating instructions prior to commissioning the device.

### 1.3 Notes for operation of the device

It is imperative that the user complies with the national accident prevention regulations.

Special reference is made to the fact that working on live parts, i.e. parts that are dangerous if touched, is only permitted if these parts have been de-energized or protected against direct contact.



### CAUTION

Only qualified, trained staff must carry out installation, electrical connection, commissioning and maintenance of the device in accordance with these Operating Instructions.

The operator shall ensure that the device is used for its intended purpose.

Unauthorized and improperly performed work during installation, electrical connection, commissioning and operation - without consulting MESSKO - is prohibited for safety reasons!

The national regulations must be observed during installation.

## 2 Product description

### 2 Product description

The MESSKO® MPreC® test bench tests and logs the accuracy and functional safety of pressure relief valves on oil-filled transformers in the disassembled state.

The mobile test bench is an additional safety package for the commissioning, operation and maintenance of transformers.



#### NOTE

The MESSKO® MPreC® test bench is only suitable for pressure relief valves which have 6 holes for attachment on the flange side and a pitch circle of 235 mm.

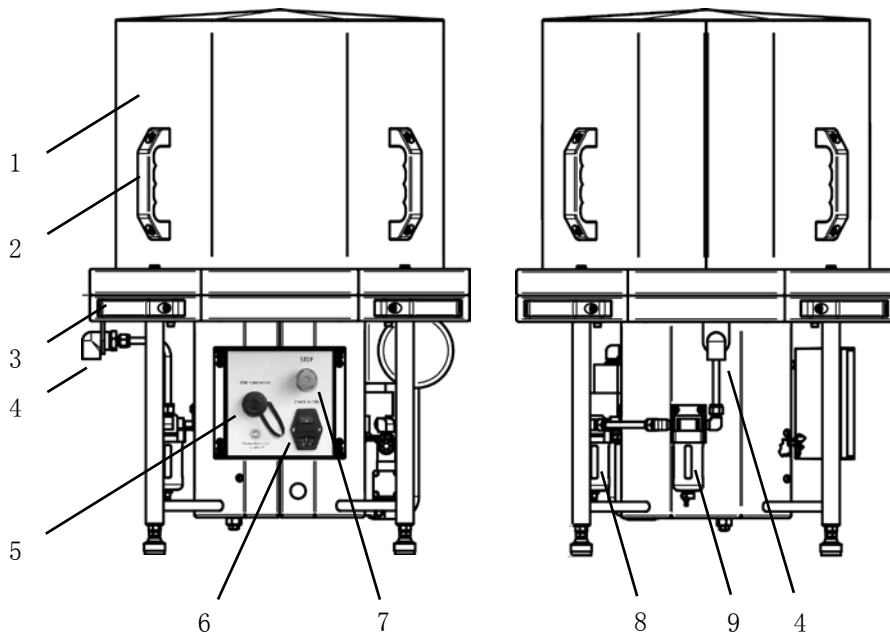









#### 2.1 Scope of supply





- 1x MESSKO® MPreC® test bench incl. hood
- 1x software for MESSKO® MPreC® test bench
- 1x USB 2.0 cable type A to type B
- 1x Operating Instructions
- 1x mains cable with IEC connector

- 1 Hood
- 2 Handle (4x on hood)
- 3 Handle (4x on base)
- 4 Compressed air connection G1/2"
- 5 USB connection
- 6 Power supply
- 7 Emergency stop
- 8 Main filter (compressed air)
- 9 Prefilter (compressed air)

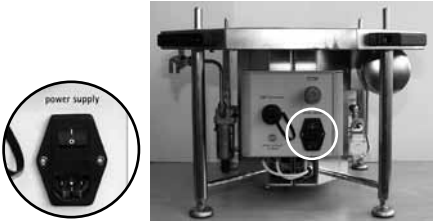
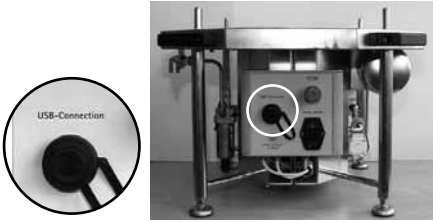

3 Commissioning

	Description	Image
1	<p>Place the MPreC® test bench on a level horizontal surface.</p> <div data-bbox="174 400 568 539" style="border: 1px solid black; padding: 5px;"> <p> <b>WARNING</b></p> <p>Ensure that the testing device has a firm base and cannot slip or tip over.</p> </div> <div data-bbox="174 564 568 687" style="border: 1px solid black; padding: 5px;"> <p> <b>CAUTION</b></p> <p>It is recommended to carry and position the test bench by two or more people (weight approx. 50 kg).</p> </div>	
2	<p>Lift the hood upwards off the base of the MPreC® test bench and store it in a safe location.</p> <div data-bbox="174 810 568 933" style="border: 1px solid black; padding: 5px;"> <p> <b>CAUTION</b></p> <p>It is recommended to lift the hood by two people from the lower part of the test bench.</p> </div>	
3	<p>Connect the compressed air supply via the existing G1/2" connection.</p> <div data-bbox="174 1075 568 1284" style="border: 1px solid black; padding: 5px;"> <p> <b>CAUTION</b></p> <p>The pressure of the compressed air fed in must be min. 4 bar and max. 10 bar.</p> <p>The national regulations must be observed for secure attachment of the compressed air supply using the existing compressed air connection.</p> </div> <div data-bbox="174 1316 568 1444" style="border: 1px solid black; padding: 5px;"> <p> <b>NOTE</b></p> <p>Use only clean compressed air in 2.2.4 quality (dust, oil and water free) in accordance with ISO 8573-1: 2001 (E).</p> </div>	 









### 3 Commissioning

	Description	Image
4	<p>Connect the power supply via the power cable supplied and switch the device on.</p> <div data-bbox="176 370 568 507" style="border: 1px solid black; padding: 5px; margin-top: 10px;">  <p style="text-align: center; margin: 0;"><b>WARNING</b></p> <p>Ensure appropriate protection against the weather as appropriate when using outdoors.</p> </div>	
5	<p>Establish a data connection to your PC or notebook using the USB port and the USB cable supplied.</p>	
6	<p>Launch the setup program of the MESSKO MPreC test bench from the CD supplied. System requirement is Microsoft Windows XP including SP 3 or a newer version of MS Windows.</p>	
7	<p>Follow the instructions of the setup wizard.</p>	
7	<p>If the installation has been successful, it is then possible to launch the software via the MPreC program icon created.</p> <p>If necessary, the program can be uninstalled via <b>“Uninstall MPreC”</b>.</p>	

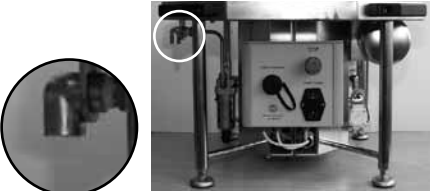
## 4 Operation

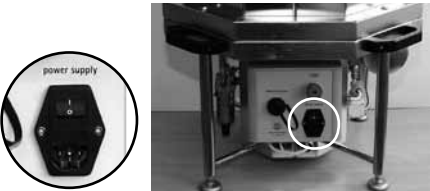
	Description	Image
1	<p>Remove the cover from the pressure relief valve to be tested.</p> <div data-bbox="176 416 568 584" style="border: 1px solid black; padding: 5px;"> <p><b>!</b> <b>NOTE</b></p> <p>Ensure that the flange side of the pressure relief valve and particularly the installation seal are free of dirt and contamination.</p> </div>	
2	<p>Use M12 screws and washers in the 6 holes on the housing flange to install the pressure relief valve on the table of the test bench. An installation seal must be fitted under the device during installation.</p> <div data-bbox="176 882 568 1010" style="border: 1px solid black; padding: 5px;"> <p><b>!</b> <b>NOTE</b></p> <p>Pay attention to the manufacturer's instructions when mounting the pressure relief valve.</p> </div>	
3	<p>Screw the pressure relief valve to the support plate of the MPreC test bench using the six M12 screws and 6 washers.</p> <div data-bbox="176 1142 568 1329" style="border: 1px solid black; padding: 5px;"> <p><b>!</b> <b>CAUTION</b></p> <p>Ensure that the length of the M12 fixing screws does not exceed the flange thickness of the pressure relief valve plus an additional 15 mm (threaded length of fixing plate).</p> </div>	

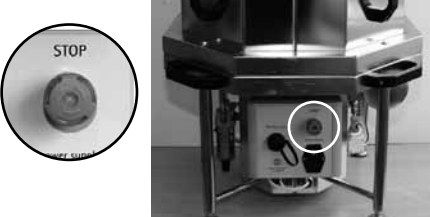

## 4 Operation

	Description	Image
4	<p>Two people are required to replace the cover on the MPreC test bench. Do not knock the signal pin when doing this.</p> <div data-bbox="172 357 568 483" style="border: 1px solid black; padding: 5px;"> <p> <b>CAUTION</b></p> <p>It is recommended to fit the hood to the lower part of the test bench by two people.</p> </div>	
6	<p>Connect the compressed air supply via the existing G1/2" connection.</p> <div data-bbox="172 568 568 780" style="border: 1px solid black; padding: 5px;"> <p> <b>CAUTION</b></p> <p>The pressure of the compressed air fed in must be min. 4 bar and max. 10 bar.</p> <p>The national regulations must be observed for secure attachment of the compressed air supply using the existing compressed air connection.</p> </div>	 <div data-bbox="617 727 1012 858" style="border: 1px solid black; padding: 5px;"> <p> <b>NOTE</b></p> <p>Use only clean compressed air in 2.2.4 quality (dust, oil and water free) in accordance with ISO 8573-1:2001 (E).</p> </div>
7	<p>Connect the power supply via the power cable supplied and switch the device on.</p> <div data-bbox="172 951 568 1107" style="border: 1px solid black; padding: 5px;"> <p> <b>WARNING</b></p> <p>Ensure appropriate protection against the weather as appropriate when using outdoors.</p> </div>	
8	<p>The LED in the centre of the emergency stop push-button lights up red during operation of the MPreC test bench.</p> <div data-bbox="172 1206 568 1362" style="border: 1px solid black; padding: 5px;"> <p> <b>CAUTION</b></p> <p>You can operate this push-button to shut down the test bench at any time after switching it on.</p> </div>	
9	<p>Establish a connection to your PC or notebook using the USB port and the USB cable supplied and launch the MPreC applications software.</p>	

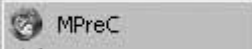
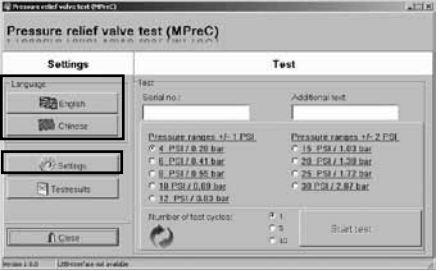
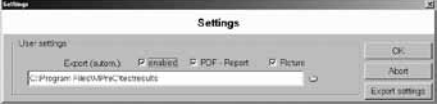
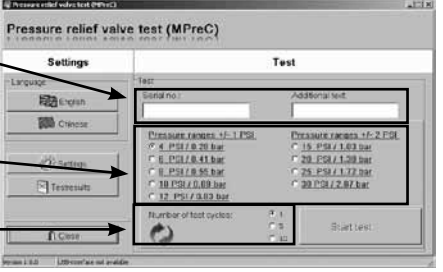
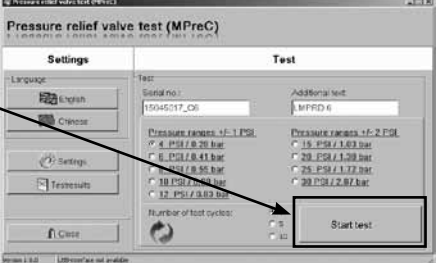

	Description	Image
10	Start the MPreC software via the program icon.	
11	Select the language of the user interface (English or Chinese). Relaunch the software to change the language.	
12	Via „Settings“ you can specify the format („PDF“ and/or „Picture“) of the test protocol.  In the command line underneath you can specify the storage path.  If the specified path does not exist you get an error message.	 <p>If „Export (autom.): enabled“ is selected, then the output file is automatically stored under the specified path as soon as the automatic test sequence is completed.</p>
13	Enter the serial number of the pressure relief valve under “Serial no.” (mandatory field). Additional text can be entered under “Additional text”.  Select the pressure range of the pressure relief valve to be tested.  Select the number of test cycles (1, 5 or 10).	
14	Start the test  <div style="border: 1px solid black; padding: 5px; margin-top: 10px;"> <p><b>NOTE</b></p> <p>After clicking the program button „Start test“ the test starts automatically and leads to loud noises when the pressure relief valve is released for pressure compensation.</p> </div>	

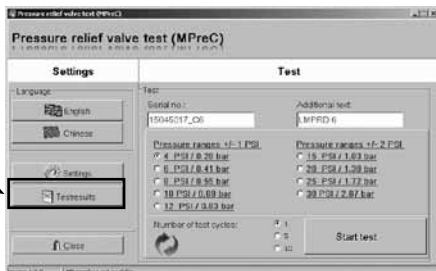
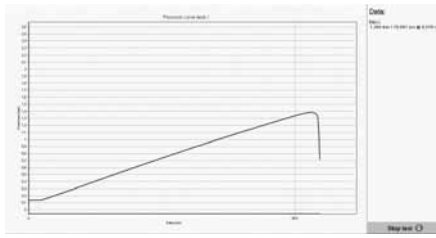
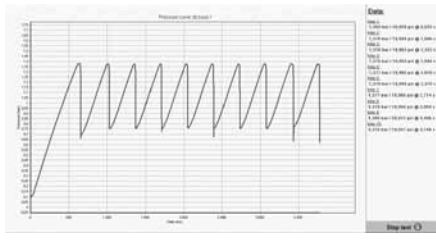
## 4 Operation

	Description	Image
15	<p>After completion of the test, select “Test results” to examine the test result.</p>	
16	<p>Example for testing with one measuring cycle.</p>	
17	<p>Example for testing with 10 measuring cycles.</p>	
18	<p>If the select box „Export (autom.): enabled“ is not selected, then the test protocol can be stored as PDF file under the specified path by selecting „PDF-Report“ und „OK“.</p> <p>By selecting „Picture“ and „OK“ the test protocol is stored as image file (jpg) under the specified path. The data file can be imported and edited in a word file or similar.</p> <p>The file save path can be changed anytime.</p>	



5 Maintenance and service

The mobile MESSKO MPreC test bench is maintenance-free.





It is recommended that the pressure transmitter is replaced or calibrated every 3 years.

5.1 Filter change

**CAUTION**  
It is essential to disconnect the pressure air supply before replacing the filter.

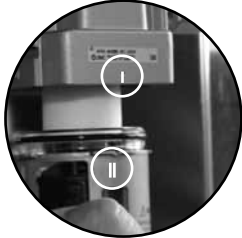
	Description	Image
1	<p>Replace the main and/or prefilter depending on the level of contamination.</p> <p>Main filter </p> <p>Prefilter </p>	<p> <b>NOTE</b> The level of contamination depends on the usage cycles and the quality of the compressed air used.</p>
2	<p>Press the prefilter's latch downwards.</p>	
3	<p>Hold the latch in position and turn the filter cartridge to the left.</p>	

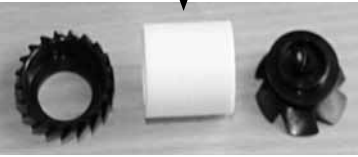
## 5 Maintenance and service

	Description	Image
4	<p>Pull the filter cartridge off downwards when the I (above) and II (below on the cartridge) marks are opposite each other.</p> 	
5	<p>Twist the filter to the left and remove.</p>	
6	<p>Separate the filter insert from the plastic top and bottom parts and replace it with a new one. Complete the installation in reverse order (steps 5, 4, 3, and 2).</p> <p>Manufacturer: SMC, Part-no. AF30P-060S</p> 	

## 5 Maintenance and service

## 6 Technical data



	Description	Image
7	Proceed in the same manner when replacing the main filter.	
8	Replace the filter insert of the main filter with a new one. In this case, the light-coloured filter and black plastic top and bottom parts form a unit and must be replaced together.  Manufacturer: SMC Part-no. AFM30P-060AS	
9	Complete the installation in reverse order (steps 5, 4, 3, and 2).	

## 6 Technical data

Housing:

Dimensions: approx. 800 mm x 600 mm  
x 600 mm

Weight: approx. 50 kg

Software: MPreC® pressure test bench  
System requirements:  
MS Windows XP incl. SP 3  
or  
newer MS Windows version;  
Language: English/Chinese;  
Measuring cycles: 1, 5 or 10 can  
be set

Power supply:

Supply voltage: 110/230 V  
Mains frequency: 50/60 Hz  
Power input: approx. 25 W

Compressed air supply:

Pressure: min. 4.0 bar to max. 10 bar  
Compressed air quality: 2.2.4 (dust, oil and water free)  
in accordance with ISO 8573-1:  
2001 (E).

Measured value of pressure:

Measuring range: 4 psi ... 30 psi  
Accuracy:  $\pm 1$  psi (range 4 psi to 12 psi)  
 $\pm 2$  psi (range 15 psi to 30 psi)

Ports:

USB: USB type B

Operating conditions:

Class of protection: IP 55 (control cabinet)  
Operating temperature:  $-10^{\circ}\text{C}$  ...  $+50^{\circ}\text{C}$

## 7 Appendix

### 7.1 Dimensions

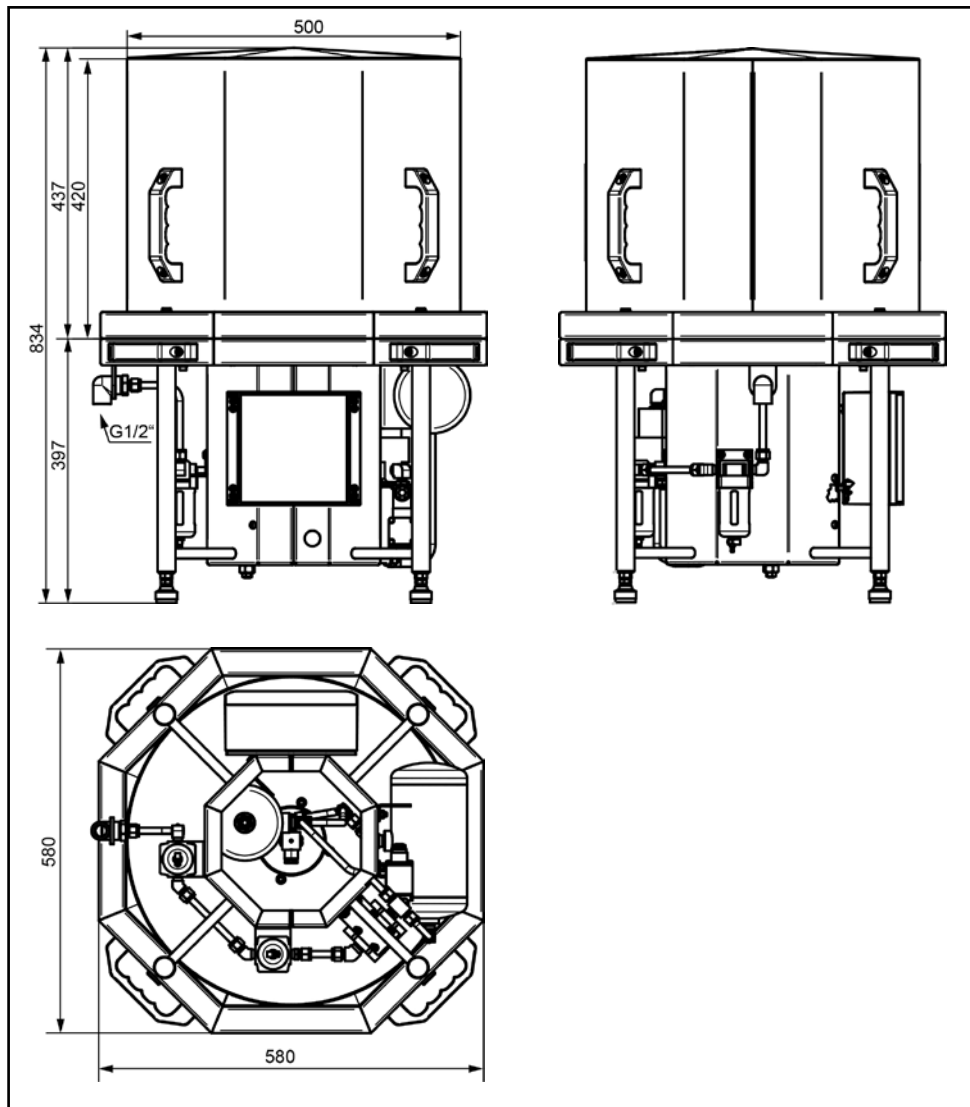



## 7.2 Test certificate



DEKRA Automobil GmbH Suchskrug 5-7 24107 Kiel

Hightec Anlagenbau  
Inhaberin Gabriele Ziegler e. K.  
Vor dem Hassel 6  
21438 Brackel

DEKRA Automobil GmbH  
Industrie, Bau und Immobilien  
Außenstelle Kiel  
Suchskrug 5-7  
24107 Kiel  
Phone +49.431.200697-70  
Fax +49.431.200697-99

Contact:  
Dipl.-Ing. (FH) Lars Götsch  
Tel. direct +49.431.200697-72  
E-Mail lars.goetsch@dekra.com  
Date 06.05.2013

## Test Certificate

**Kind of test:** Check of documents, functional ad tightness test  
**Legal basis:** 97/23/EG; Art. 3, cl. 3  
**Tests location:** Hightec Anlagenbau  
Vor dem Hassel 6; D- 21438 Brackel

**Kind of pressure equipment:** Test facility for safety valves

<b>Data of construction:</b>	
Category acc. to PED 97/23/EG	Art. 3 cl. 3
Application	Test facility for control and testing of safety valves
Manufacturer	Hightec Anlagenbau, 21438 Brackel
Manufacturing No. / Code	78666200
Max. all. pressure PS	12 bar
Year of built	04.2013
Assembly / location	mobile test facility

<b>Test result:</b>	The test facility is due to the test results <input checked="" type="checkbox"/> suitable for the intended use. <input type="checkbox"/> not suitable
<b>Remarks:</b> In the course of testing the a.m. test facility was checked in respect to function, tightness and assembly. Furthermore the assembly was compared and assessed with the available documentation. The documentation included drawings (No. 12-055-01-000), adjustment certificates as well as manufacturer documents of the used components.	

  
Dipl.-Ing. (FH) Lars Götsch  
Authorised Inspector Pressure Equipment



Stempel

DEKRA Automobil GmbH  
Handwerkerstraße 15  
D-70555 Stuttgart  
Telefon +49 711 7861-0  
Telefax +49 711 7861-2240  
www.dekra.com

Sitz Stuttgart, Amtsgericht Stuttgart  
HRB-Nr. 21039  
Bankverbindung  
Commerzbank AG  
(BLZ 600 800 00) Kto.-Nr. 9 010 051 00  
Landesbank Baden-Württemberg  
IBAN: DE 25 12 05 10 051 000 000 00

Vorsitzender des Aufsichtsrates  
Stefan Kolitz  
Geschäftsführer:  
Clarens Kinke (Vorsitzender)  
Wolfgang Linsenmair  
Dr. Gerd Neumann

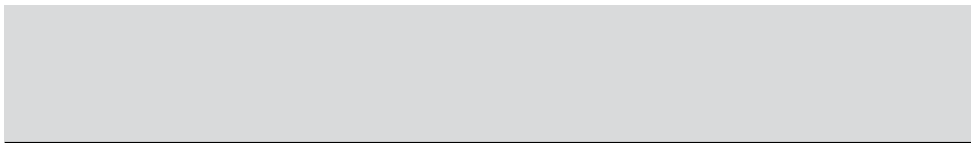



Messko GmbH  
Gewerbegebiet An den Drei Hasen  
Messko-Platz 1, 61440 Oberursel,  
Germany

Phone: +49 6171 6398-0  
Fax: +49 6171 6398-98  
E-Mail: [info@messko.com](mailto:info@messko.com)

[www.messko.com](http://www.messko.com)

Please note:

The data in our publications may differ from  
the data of the devices delivered. We reserve  
the right to make changes without notice.

BA 3451814/00 ZH-EN – MPreC® Test Bench –  
79104700 – 08/13  
©Messko GmbH 2013

THE POWER BEHIND POWER.

