

ReCoTec®  
ROTAFIL®

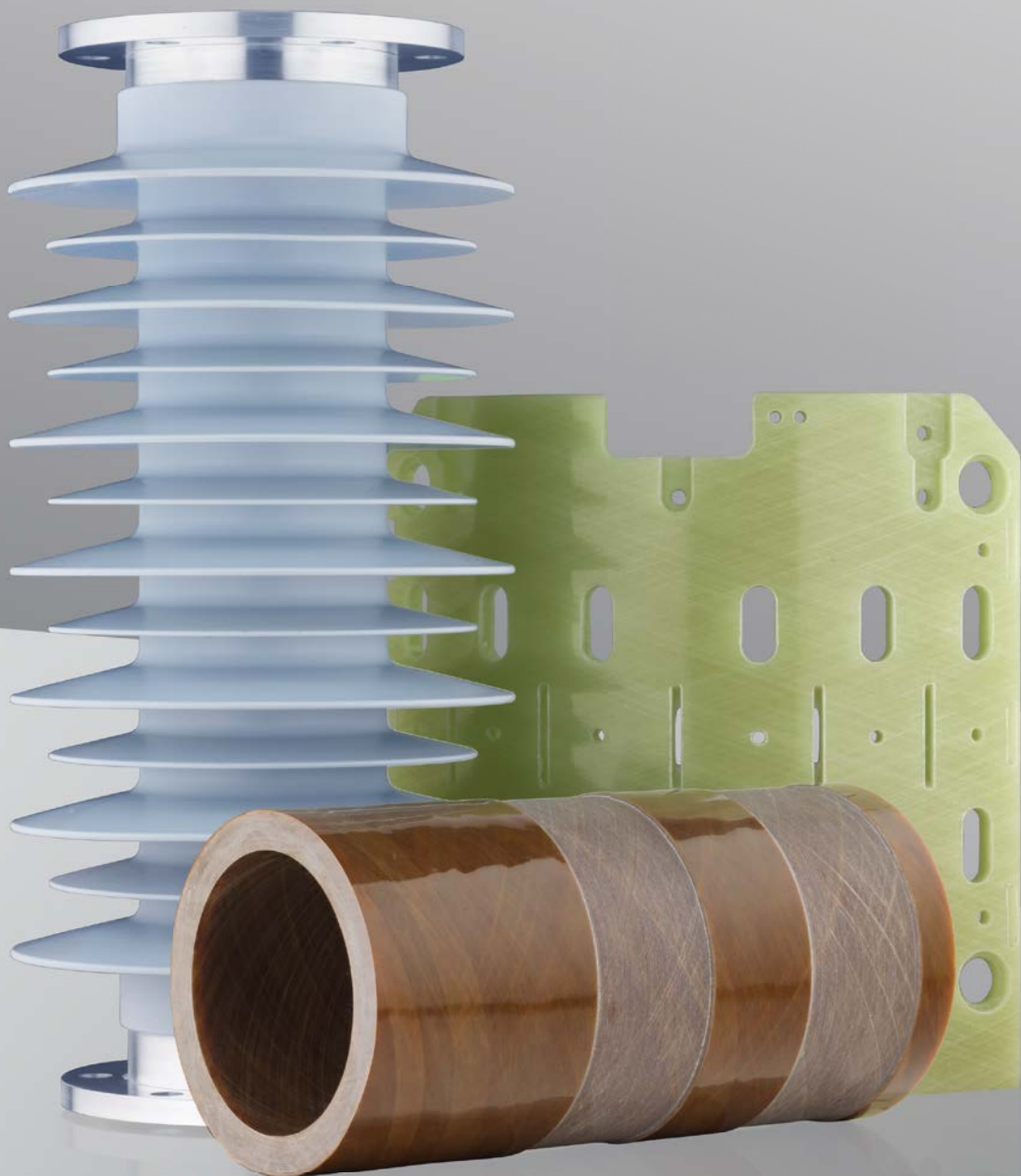

# COMPOSITE MATERIALS FOR HIGHEST ELECTRICAL AND MECHANICAL REQUIREMENTS.

POWER COMPOSITES



# ReCoTec® – HIGH QUALITY MADE IN GERMANY.



# BECAUSE „GOOD“ IS NOT GOOD ENOUGH.

The Reinhausen Power Composites (RPC) success story began over 30 years ago when Maschinenfabrik Reinhausen (MR) needed insulating tubes made from fiberglass-reinforced epoxy resin in order to produce MR on-load tap-changers. The products available on the market at that time were not able to meet the stringent quality requirements of MR. So the solution was to design, produce and process them in-house. The results were composite materials of a unique quality which also proved to be the cornerstone for a new company division.

Meanwhile a significant part of the tube production is sold under the brand **ROTAFIL®** to external customers with similar high quality standards. Examples of applications: insulating housings for high voltage apparatus, bobbins for coils in medical equipment as well as in reactors, transformers and insulating shafts of rotating machines.

Based on this know-how and experience it was a logical step to expand the business field of insulation material and offer hollow composite insulators in MR quality to the market. Under the brand name **ReCoTec®** (Reinhausen Composite Technology) a continuously growing range of

hollow insulators with silicone rubber sheds for outdoor applications as well as without sheds for indoor use is available.

Due to the success and rapid growth of the new business field, all activities of MR regarding composite materials and insulators have been organized as a legally independent entity since August 1<sup>st</sup>, 2009. The company with the trade name "Reinhausen Power Composites GmbH" is a 100% subsidiary of Maschinenfabrik Reinhausen GmbH.



# HOLLOW COMPOSITE INSULATORS.

Under the ReCoTec® brand name, we manufacture hollow composite insulators with silicone shielding based on our ROTAFIL® cylinders.

ReCoTec® hollow composite insulators offer a number of advantages compared to conventional porcelain insulators. They are substantially lighter, extremely durable and earthquake resistant. They maintain their water-repellent characteristics, and thus their excellent insulating properties, even under extreme environmental conditions. In the event of failure or external damage, they are explosion-proof and do not scatter hazardous parts.

30 years of experience in dimensioning, producing and processing fiberglass-reinforced tubes and state-of-the-art production equipment is your guarantee of a very high level of reliability. To achieve these goals at the development stage, the insulators are designed with CAD systems and programs for mechanical and electrical FEM calculations. Our operation is also DIN EN ISO 9001 and DIN EN ISO 14001 and certified for health and safety management in accordance with OHRIS which is equivalent to ILO-OSH / DIN ISO 18001. Ultra-modern test equipment and regular inspection of all materials and production processes far beyond the requirements of relevant standards ensure this quality. Additionally, all of this is done in a very short delivery period.

- All requirements of IEC 61462 and IEC 62217 fulfilled
- Salt fog test passed with increased salinity above the standard requirement
- Mechanical and tightness test passed at -60°C and +105°C
- Resistance against various insulation fluids and SF6 decomposition products proven

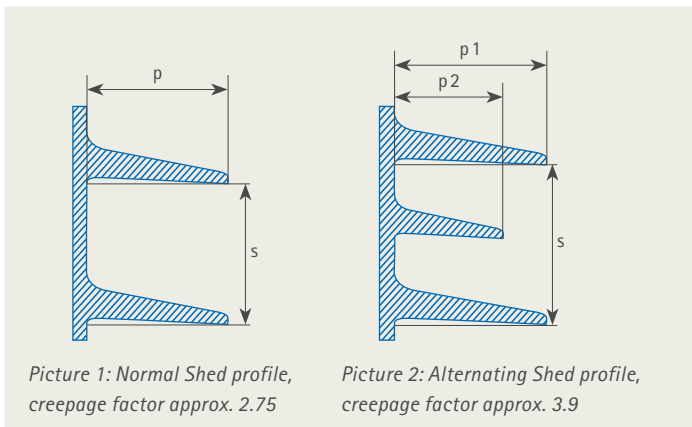

## Advanced materials and processes:

- FRP manufactured with e-glass and epoxy resin
- Ozone and UV resistant liquid silicone rubber (LSR)
- Tracking and erosion resistance 4.5 kV in class 1a
- Proven hydrophobicity recovery within 24 hours
- Flammability classification VO

## Sheds:

- Shed profile optimized under IEC 60815-3
- All sheds with inclined underside
- Optimal creepage distances
- Low leakage currents
- Special HVDC profile available

Inner tube diameter d [mm]	Outer tube diameter d [mm]	Outer shed diameter d [mm]
80/85	90	198
98/100/107	112	230
100/107/110/120	132	240
110/120/130	142	250
135/150/158/160	172	280
180/190/198/200	210	318
200/205/211/220	232	340
230/240/248/250	260	368
273/290/298	310	434
320/330/340/350	362	486
358/375	395	533
479/486/496/500	510	634
560/580/586/595	615	753
710/760/770	790	928

Available standard insulator dimensions.  
We will send you further information on your kind request.

Filament winding tubes are available in the following standard designs:

PFWL pressure tube

PBFWL combined pressure and bending tube

BFWL bending tube

TFWL torsion tube

Laminates for special applications on request.

# ReCoTec® INNOVATIONS.

Our innovations, such as conical ReCoTec® insulators, ReCoTec® with integrated fiber-optic cables and ReCoTec® with flanges made of FRP material, help our customers expand and secure their market leadership.

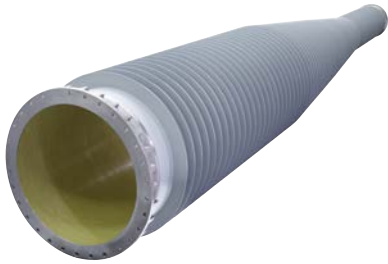

## Conical ReCoTec® insulators

- Reduce insulation medium use by up to 50% (oil or gas)
- Reduce the size of equalizing tanks
- Increase the phase to phase distance

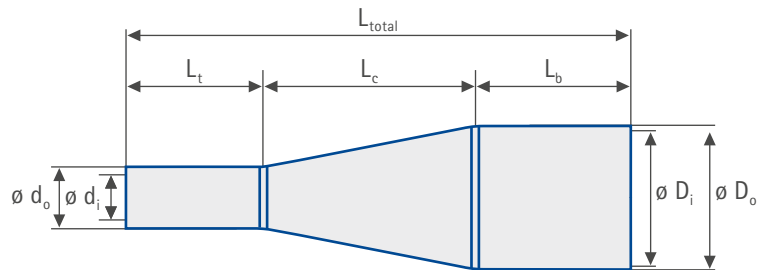

## ReCoTec® with integrated optical fibers

The integrated fiber-optic cables can be used for current and voltage transformers and support insulators for exchanging measurement and optical signals between high-voltage and ground.

Primary characteristics:

- Up to 24 individual fibers possible
- Connections based on customer specifications
- Hollow or with filling-media

## ReCoTec® without silicone

Primarily for use in indoor applications and GIS systems. Different protecting layers (lacquering) possible on customer request.



# ReCoTec® INNOVATIONS.

## ReCoTec® post insulators

- For HVDC projects and
- For high-voltage substations

### Features:

- Ready for assembly
- Available in one or two parts for easier transportation and handling
- Pressure monitor systems available on demand

# MORE POWER, MORE VALUE.

ReCoTec® hollow composite insulators for high voltage apparatus insulators offer a number of advantages over traditional porcelain housings:



## Cost reduction in equipment manufacturing and installation

- Low weight eases handling, transport and installation
- High impact and shock resistance avoids damage caused by handling errors and vandalism, no additional costs and delays caused by damaged insulators



## Quick and reliable

- Short and reliable process times for insulators, equipment and substations
- Flexible adjustment to different operating conditions because mechanical properties can be widely influenced by design
- Low manufacturing tolerances enable precise adjustment to the installed device



## Safety

- High mechanical strength and adjustable flexibility for optimal seismic performance and low risk of damage by vandalism
- No dangerous fragments result if the housing is destroyed by internal or external influences, no secondary damage to surrounding equipment and no danger for persons in the vicinity



## Maximum operational reliability

- Excellent flash-over resistance under contamination and humidity conditions due to hydrophobicity and hydrophobicity transfer, superior insulating abilities in difficult environments
- Extremely good bonding of tube-flange interface, better leakage properties

# ROTAFIL® – THE FUTURE OF FILAMENT WINDING TECHNOLOGY.

Certified tubes of Reinhausen Power Composites for the highest electrical and mechanical requirements.

ROTAFIL® tubes are manufactured using the filament winding technology. Numerically controlled (NC) winding machines wind the resin-impregnated glass fibers on to a mandrel. The winding angles vary depending on the mechanical requirements. After winding, the epoxy resin is cured in temperature controlled conveyor furnaces. Until the resin is completely cured, the mandrels are kept rotating to avoid displacement of the resin. Finally, the material is cooled to room temperature and the mandrel is pulled out of the tube.

## Materials

To meet high electrical and mechanical requirements, RPC uses only e-glass fibers and high-temperature curing-epoxy resins from renowned suppliers for the production of ROTAFIL® tubes.

## Surfaces

As a standard, ROTAFIL® tubes are equipped with a polyester liner on the inner and outer surface. The polyester fleece is saturated with epoxy resin before winding. Thus, it provides a layer of resin below and above the FRP material. This layers provide smooth surfaces which need no further treatment. Furthermore, the inner layer protects the glass fibers against the decomposition products of SF<sub>6</sub> in switching devices. This ability has been proven in special tests performed by circuit breaker manufacturers.

On special request, the tubes can also be supplied without the liners on one or both surfaces and the surfaces can be grinded and varnished.

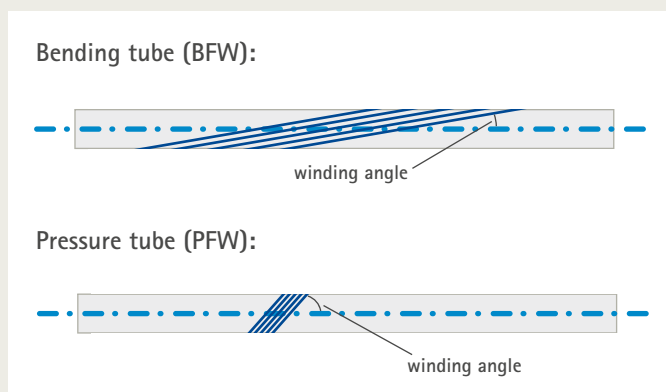
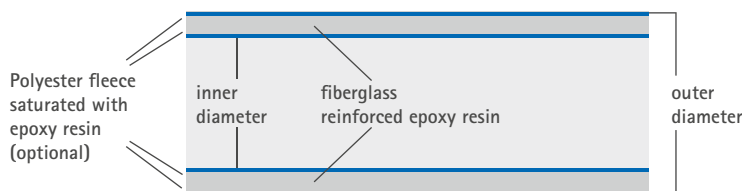

## Design & dimensions

At present, ROTAFIL® tubes are available in diameters from 28 mm to 1000 mm. The winding angle is the angle between the glass fibers and the axis of the tube. Small winding angles result in tubes with high bending strength (BFW) and large angles in pressure resistant tubes (PFW). Different angles can also be combined to produce tubes which can withstand high bending forces as well as high internal pressure (PBFW).



## Certified quality

From each batch of materials used for production, samples are taken and tested in a special testing lab. Glass content, glass transition temperature ( $T_g$ ) and electrical puncture voltage are regularly measured on samples of finished products in accordance with a test plan.

Of course, Reinhausen Power Composites is certified according to ISO 9001, ISO 14001 and OHRIS equivalent to ILO-OSH / DIN ISO 18001.



*Frequent quality controls and 100% traceability of the materials used.*



# ROTAFIL®.



## High-temperature resin

Since the temperature in electrotechnical devices is very often the dominant aging factor, we offer a high-temperature resin system with a glass transition temperature  $T_g$  of 156°C (thermal class H). This system has almost the same characteristics as the standard resin system with a  $T_g$  of 128°C.

## Assembly competence

For 30 years, our skilled workers have assembled metallic and plastic parts on different GFRP tubes. For more than 20 years, we have also used our competence to pre-assemble products for other customers.

## Machining center

In addition to manufacturing FRP tubes, Reinhausen Power Composites has extensive abilities and experience in machining these tubes. Our production is equipped with various NC machining centers to perform all relevant operations:

- Saws with diamond-equipped blades for cutting to the designed length
- Machines for drilling, milling, turning and grinding
- Lathes of different sizes mainly for processing the ends of the tubes
- Several manual work stations for finishing and quality control

All machines and work stations are operated by skilled workers who are regularly trained.



# ROTAFIL® APPLICATIONS.

ROTAFIL® is always the product of choice if high electrical, mechanical and precision requirements are to be fulfilled continuously and consistently.

## On-load tap-changers

For about 30 years ROTAFIL® tubes have been used in various functions in MR's tap changers. The tubes serve as housings, drive shafts, contact carriers, and more. The electrical as well as mechanical requirements are very high in this application and the tubes need to be machined in many different ways.

## Transformer production

Various transformer manufactures are replacing old-fashioned hard-paper cylinders with modern GFRP tubes. This ensures higher quality in electrical and mechanical behavior. Most common applications are arc suppression coils or cylinders for transformer windings. Additionally, various applications are possible to increase the quality and reliability of transformers.

## Bobbins for high frequency coils in computer and magnetic resonance tomography

Another long-term and very successful application is in the use of bobbins for high frequency coils in computer and magnetic resonance tomography. For this field of use, very precise production and machining is essential to maintain all dimensions and properties within extremely low tolerances.

## Hollow composite insulators

For many years ROTAFIL® tubes have been used as support tubes for hollow composite insulators by several customers. In 2007 RPC started its own manufacturing of this modern type of high-voltage outdoor and indoor insulators under the brand name ReCoTec®.

## Other applications

Other common applications include winding supports for reactors, insulating spacers and housings in high-voltage testing equipment and insulating pipes for measuring devices, among others.



Magnetic Resonance Tomography application for customer SIEMENS

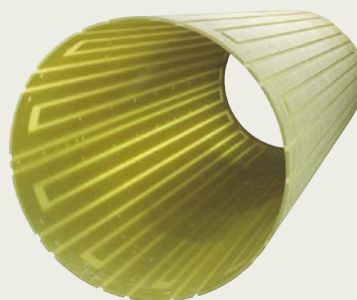

GFRP tube with machined cooling channels



On-load tap-changer VACUTAP® VV®

# MORE POWER, MORE VALUE.

Leading technology products from Reinhausen Power Composites are the perfect solution for meeting the highest requirements.



## Quick and reliable

- Decades of experience in the production and processing of tubes made from fiberglass-reinforced epoxy resin
- The winding angles vary depending on the mechanical requirements
- Low manufacturing tolerances enable precise adjustment to the installed device
- For applications with varying operating temperatures, two types of FRP tubes are available with glass transition temperatures ( $T_g$ ) of 128°C and 156°C
- Certified in accordance with ISO 9001, ISO 14001 and OHRIS which is equivalent to ILO-OSH / DIN ISO 18001



## Maximum operational reliability

- RPC uses only e-glass fibers and high-temperature curing-epoxy resins from renowned suppliers for the production of ROTAFIL® tubes



ReCoTec® – HIGH QUALITY  
FOR HIGHEST DEMANDS.



# INSULATOR SPECIFICATION FORM

E-mail to: [rpc@reinhausen.com](mailto:rpc@reinhausen.com)

Customer

Contact person

Quotation No.

Specification

Customer drawing No.

Project

Insulating medium

Application

Service temperature min  °C max  °C

Voltage class AC  DC   kV

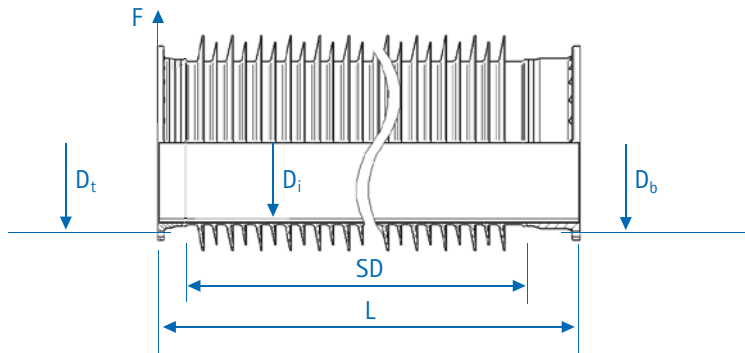

## Dimensional data insulator

Length (L)  mm

Minimum inner diameter ( $D_i$ )  mm

Minimum strike distance (SD)  mm

Minimum creepage distance  mm

## Top flange

Type of holes [ $\phi$  mm] / [M]

Number of holes

BCD top flange ( $D_t$ )  mm

Flange number (if available)

## Mechanical data acc. IEC 61462

Maximum mechanical load (MML)  N

Maximum deflection at MML  mm

Maximum service pressure (MSP)  bar

Specified internal pressure (SIP)  bar

## Bottom flange

Type of holes [ $\phi$  mm] / [M]

Number of holes

BCD bottom flange ( $D_b$ )  mm

Flange number (if available)

## Project information

Annual (series production)  project quantity

First quantity (e.g. for qualification, prototype)

First delivery (at customer)

pieces

pieces

date

## Comments

---

---

---

# NOTES

**Reinhausen Power Composites GmbH**

Weidener Strasse 20  
93057 Regensburg, Germany

Phone: +49 941 4090-2860

Fax: +49 941 4090-500

E-mail: [rpc@reinhausen.com](mailto:rpc@reinhausen.com)

[www.reinhausen.com](http://www.reinhausen.com)

Please note:

The data in our publications may differ from  
the data of the devices delivered. We reserve  
the right to make changes without notice.

IN3534366/02 EN – RECOTEC® / ROTAFIL®

F0311802 – 01/16– uw –

©Maschinenfabrik Reinhausen GmbH 2013

THE POWER BEHIND POWER.

