

Unpacking Instructions OILTAP® G

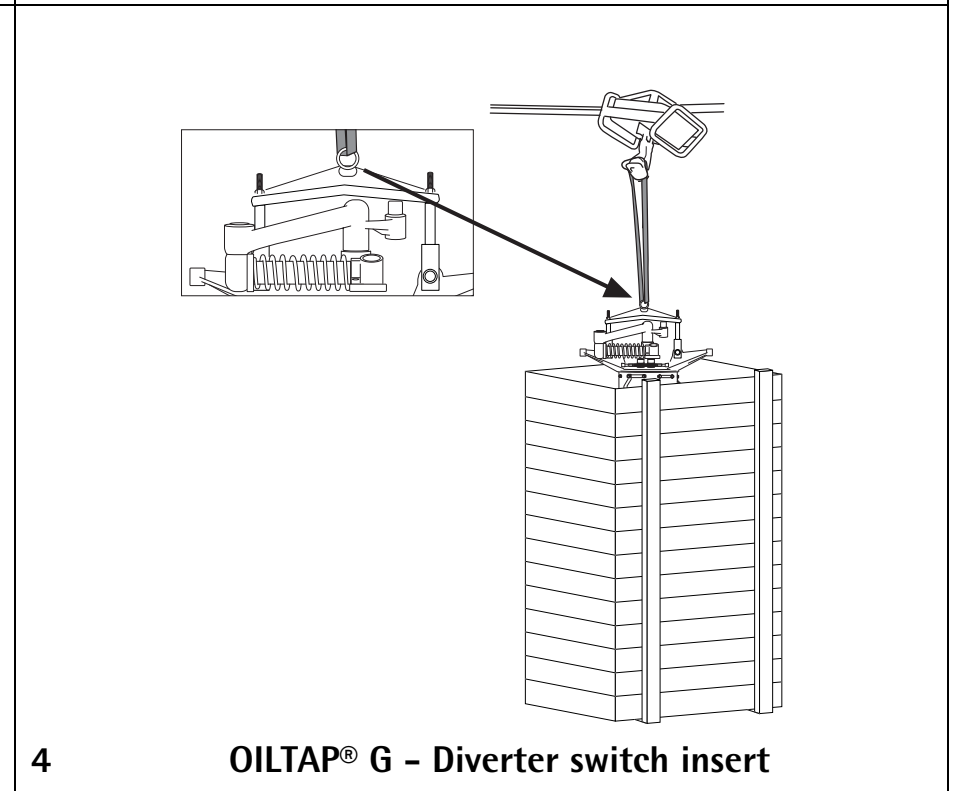
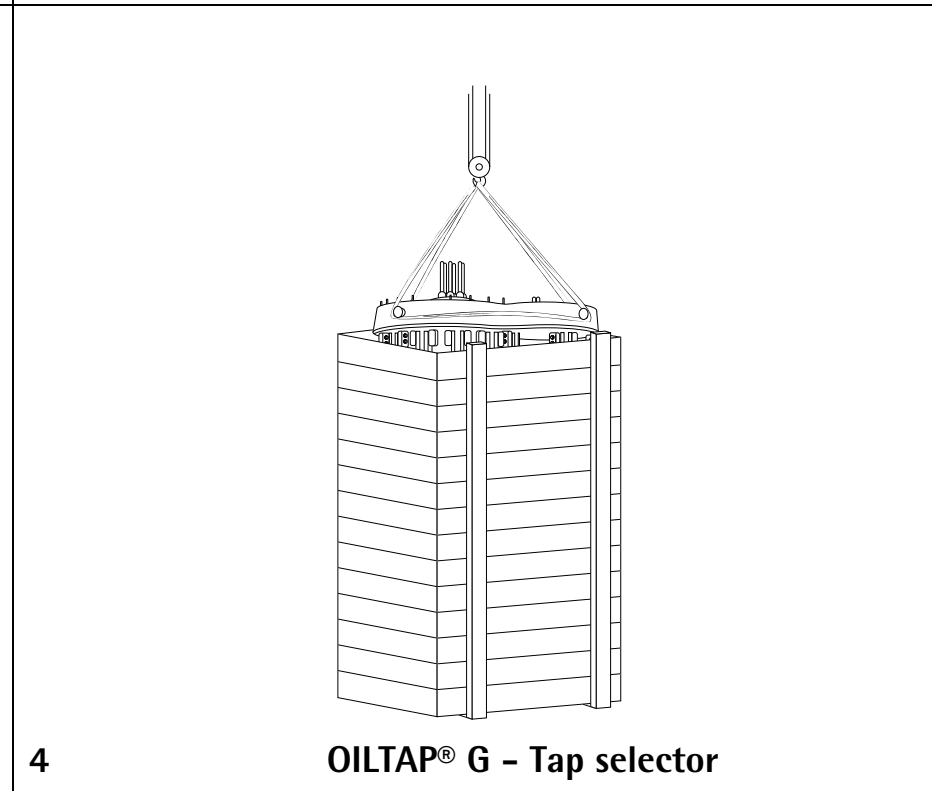
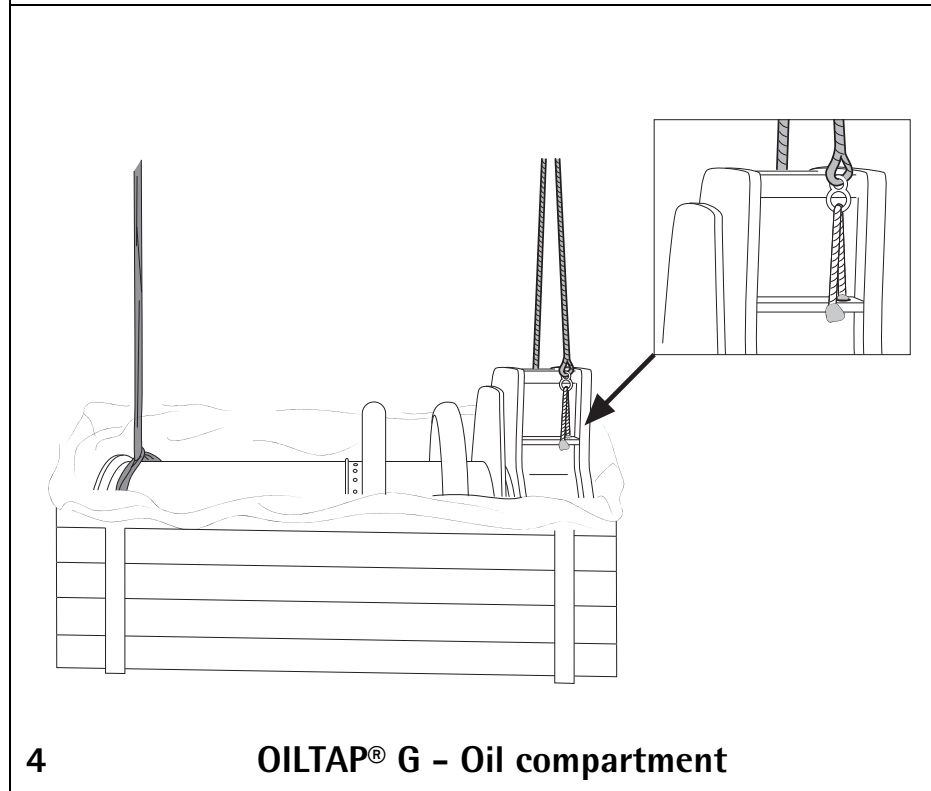
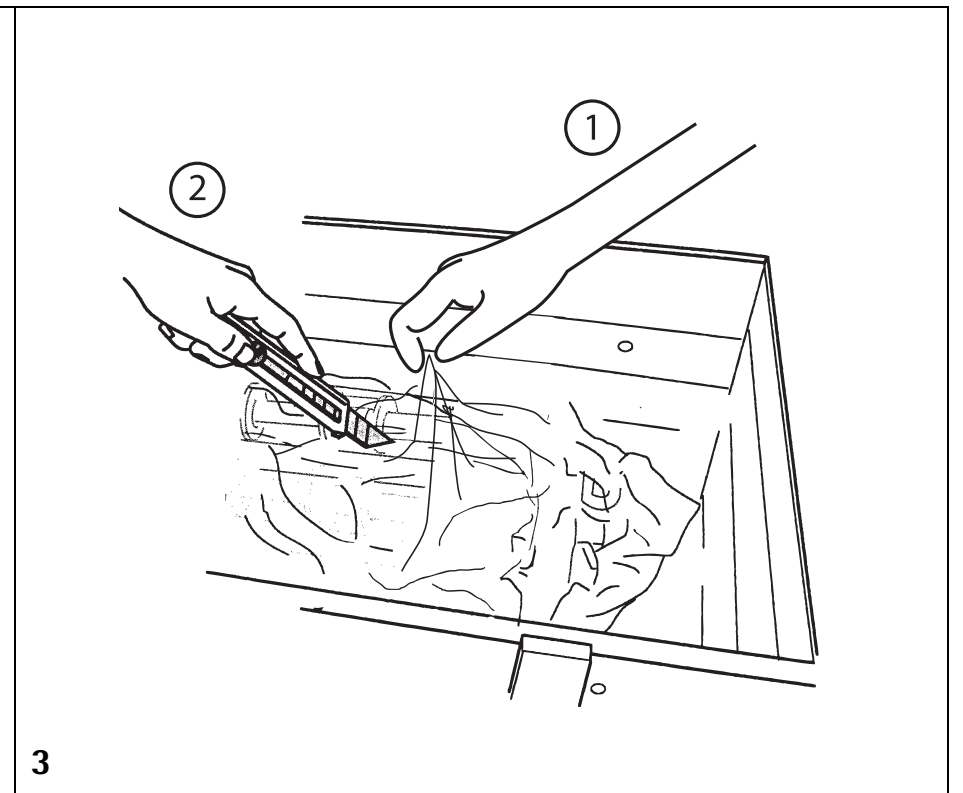
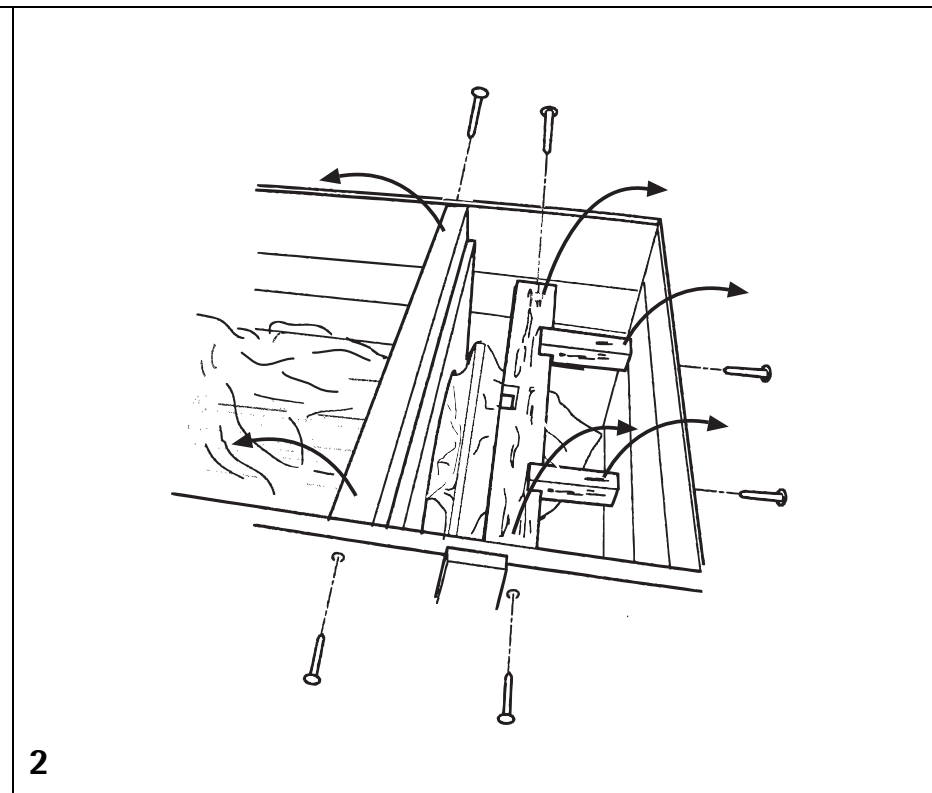
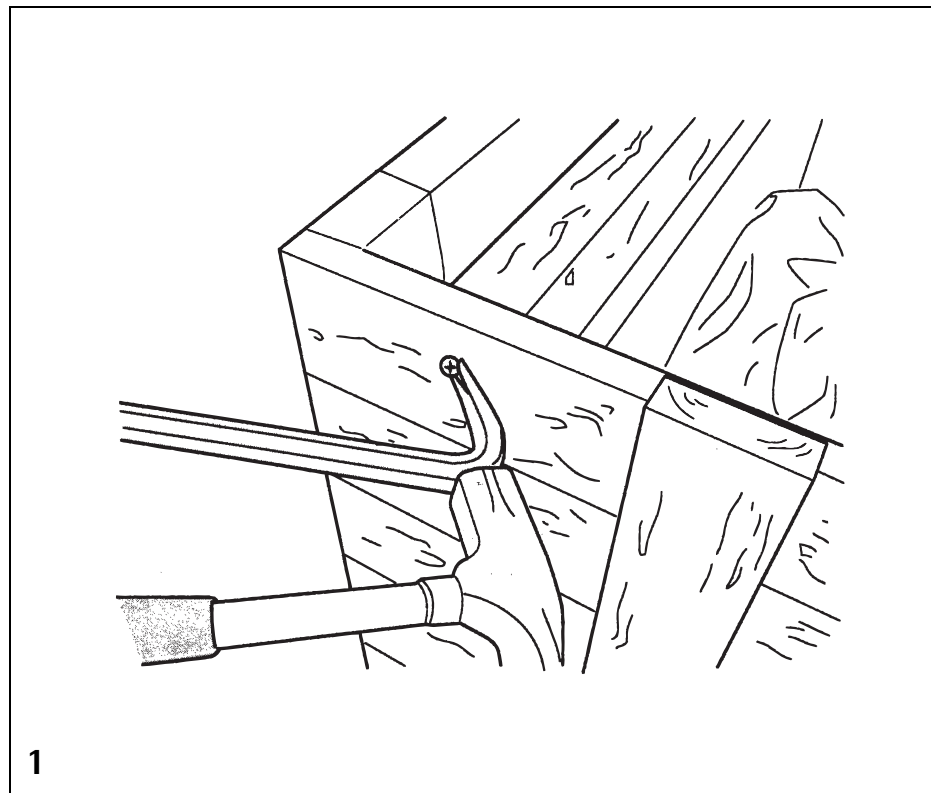

4 OILTAP® G - Oil compartment

4 OILTAP® G - Tap selector

4 OILTAP® G - Diverter switch insert

Unpacking Instructions 2060416/00 EN Unpacking Instructions OILTAP® G

The copying, distribution and utilization of this document as well as the communication of its contents to others without expressed authorization is prohibited. Offenders will be held liable for the payment of damages. All rights reserved in the event of the grant of a patent, utility model or ornamental design registration.

©Maschinenfabrik Reinhausen GmbH 2009

Unpacking Instructions OILTAP® G

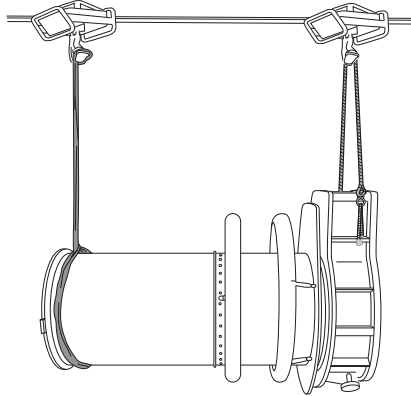
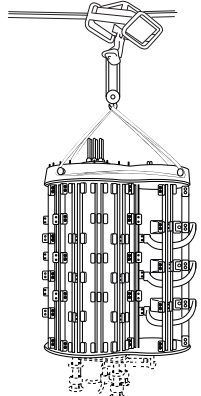
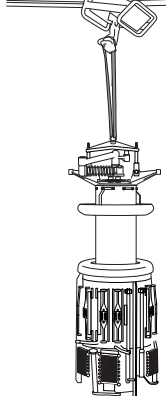
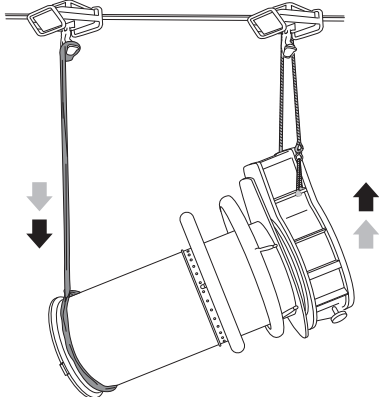
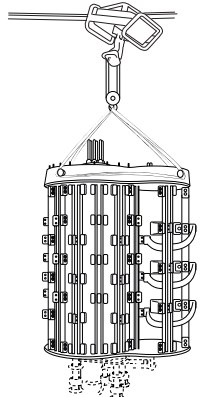
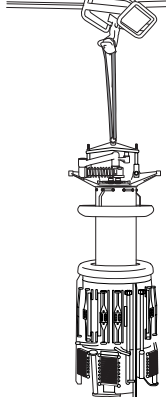
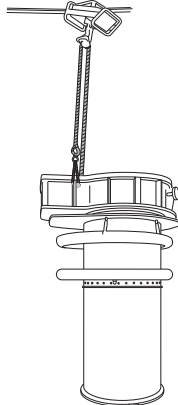
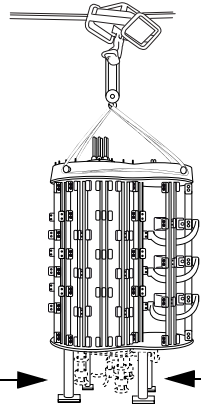
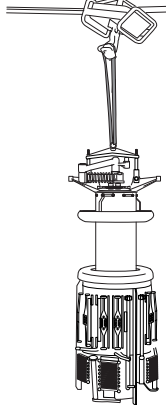

 <p>5 OILTAP® G - Oil compartment</p>	 <p>5 OILTAP® G - Tap selector</p>	 <p>5 OILTAP® G - Diverter switch insert</p>
 <p>6 OILTAP® G - Oil compartment</p>	 <p>6 OILTAP® G - Tap selector</p>	 <p>6 OILTAP® G - Diverter switch insert</p>
 <p>7 OILTAP® G - Oil compartment</p>	 <p>7 OILTAP® G - Tap selector</p>	 <p>7 OILTAP® G - Diverter switch insert</p>

Unpacking Instructions 2060416/00 EN Unpacking Instructions OILTAP® G

The copying, distribution and utilization of this document as well as the communication of its contents to others without expressed authorization is prohibited. Offenders will be held liable for the payment of damages. All rights reserved in the event of the grant of a patent, utility model or ornamental design registration.

©Maschinenfabrik Reinhausen GmbH 2009