

Digital OLTC Voltage Controller TAPCON® 250

TAPCON® 250 Adapter Panel TC250-67

Supplement BB03_29702010

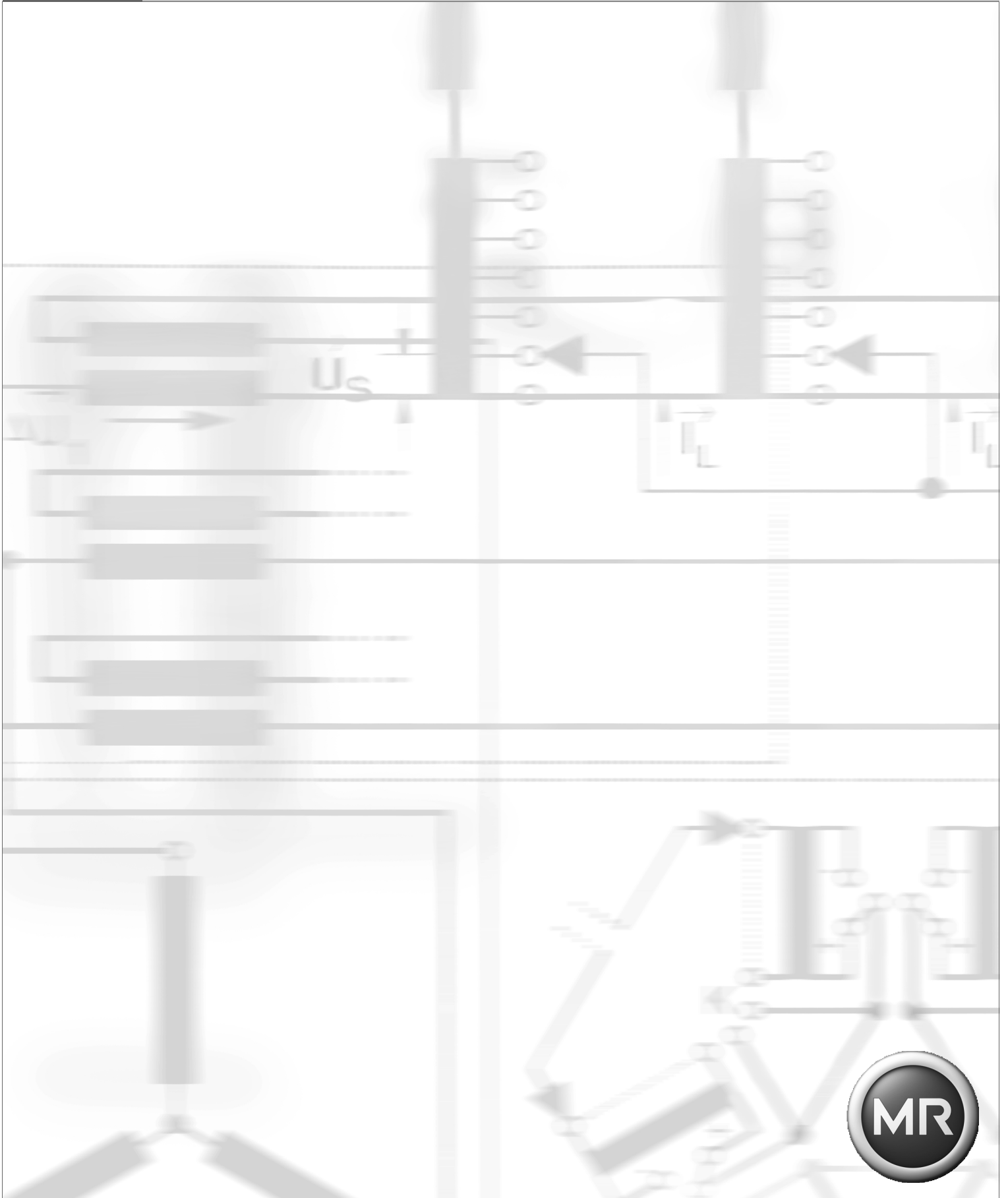

Table of Contents

1	Safety.....	1
1.1	Safety labels.....	1
1.2	Safety instructions	1
2	General	3
2.1	Foreword.....	3
2.2	Manufacturer.....	3
2.3	Warranty and Liability.....	3
2.4	Specified Application	3
3	Commissioning.....	4
3.1	Installation.....	4
3.2	Connection	6
3.3	External Connections.....	7



NOTE!

Information in this document is subject to change without notice. No part of this document may be reproduced or transmitted in any form or by any means, electronic or mechanical, for any purpose without the express written permission of Maschinenfabrik Reinhausen GmbH.
For further information, contact Reinhausen Mfg.





© 2007 Maschinenfabrik Reinhausen GmbH. All rights reserved.





1 Safety

1.1 Safety labels

The following safety labels relating to the operation of the TAPCON® 250 are used in these operating instructions. These labels must be observed at all times!

	<p style="text-align: center;">DANGER!</p> <p>Refers to an <i>imminent danger</i> that may result in death or severe injury.</p>
	<p style="text-align: center;">WARNING!</p> <p>Refers to a <i>potentially hazardous situation</i> that may result in death or severe injury.</p>
	<p style="text-align: center;">CAUTION!</p> <p>Refers to a <i>potentially hazardous situation</i> that may result in slight injury or material damage.</p>
	<p style="text-align: center;">NOTE!</p> <p>Contains important information and special notes.</p>

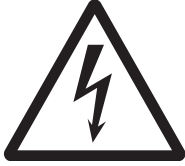
The following specific safety warnings are used in these operating instructions

	
<p style="text-align: center;">Risk of electric shock!</p>	<p style="text-align: center;">Fire hazard!</p>

1.2 Safety instructions

- **All warnings and safety instructions must be observed at all times!**

Danger of death and risk of injury! Not following the safety instructions may lead to accidents and severe personal injury.

- **Please read these operating instructions before commissioning the equipment!**

Read the operating instructions before commissioning the TAPCON® 250.

As operator, you are responsible for ensuring that users of the equipment have fully understood the operating and safety instructions.

- **Always connect the TAPCON® 250 to an electrical ground!**

To avoid shock hazard, the chassis must be connected to an electrical ground. When servicing the TAPCON® 250 in a test area, the protective earth terminal must be attached to a separate ground securely by use of a tool since it is not grounded by external connectors.

TAPCON® 250 Adapter Panel TC250 - 67

- **Only suitably qualified personnel should work at the TAPCON® 250!**

The TAPCON® 250 contains high voltages which can cause serious injury or death! It is designed exclusively for application in electrical or energy systems and facilities operated by appropriately trained staff who are familiar with the installation, operation and maintenance of such products.

Exercise due care when operating or servicing alone.

- **Do not operate the TAPCON® 250 in an explosive environment!**

Do not operate this equipment in the presence of flammable or explosive gases or fumes. To do so would risk a possible fire or explosion.

- **Keep away from live circuits!**

Operating personnel must not remove the cover or expose the printed circuit board while power is applied. Dangerous voltages may exist even when power is disconnected. To avoid electrical shock, always disconnect power and discharge circuits before working on the unit.

- **Do not modify the TAPCON® 250!**

Do not perform any unauthorized changes on the TAPCON® 250. Contact Reinhausen Manufacturing regarding any modification. If authorized modifications are to be attempted, be sure to follow replacement procedures carefully to assure that safety features are maintained.

- **Avoid static charge!**

The TAPCON® 250 contains MOS circuitry which can be damaged by improper test or rework procedures. Avoid static charge on work surfaces and service personnel.

- **Use extreme caution during any diagnostic work!**

Any attempt to perform any diagnostic work or connection between points on the printed circuit board, unless services noted in the Operating Instructions is likely to cause damage or permanent failure to the TAPCON® 250.



2 General

2.1 Foreword

These operating instructions relate to the TC250-67 adapter panel for Reinhausen's voltage controller TAPCON® 250. They describe the necessary connections for electronic voltage regulation of tap changers in power transformers.

Please read these instructions before commissioning the TC250-67 adapter panel together with the TAPCON® 250. The operator is responsible for ensuring that users of the device have fully understood the operating and safety instructions.

More comprehensive information about the configuration and operating principle of the voltage controller along with settings for special applications can be found in the following document: Operating instructions BA297 "Digital On-Load Tap Changer Voltage Controller TAPCON® 250".

2.2 Manufacturer

The voltage controller TAPCON® 250 is manufactured by:

Reinhausen Manufacturing Inc.
2549 North 9th Avenue
Humboldt, Tennessee 38343, USA

Phone: (+1)731/784-7681

Fax: (+1)731/784-7682

Email: reinhausen@bestlinc.com

Further copies of these operating instructions are available from the above address, if required.

2.3 Warranty and Liability

Warranty and liability claims for personal injury or damage to property are excluded, if they were caused by one or more of the following:

- Inappropriate use of the TC250-67.
- Improper commissioning and operation of the TC250-67.
- Operation of the TC250-67 with safety equipment that is faulty, or with safety or protection equipment that is installed incorrectly or non-functioning.
- Non-adherence to the notes in the operating instructions with regard to installation, commissioning and operation of the TC250-67.
- Unauthorized modification of the TC250-67.

The adapter panel TC250-67 is offered with an extended warranty.

2.4 Specified Application

An adapter panel or a surface mounting kit must be used with the TAPCON® 250. Each panel adapts the TAPCON® 250 as a transformer control replacement and provides the external connections necessary for operation via terminal blocks on the rear of the adapter panel.

The adapter panel TC250-67 in combination with the TAPCON® 250 voltage controller is used for automatic control of transformers with motor-driven tap-changers. The motordrive mechanism receives the corresponding control signals from the voltage controller. With these signals, the tap-changer moves to the next position and the transformer's voltage value is adapted to the preset reference voltage level.

The TC250-67 is a general purpose adapter panel designed for mounting in existing or new control schemes, fitting in a 5-7/8" x 15-1/8" (162 x 419 mm) cut out. It can also be used to replace Westinghouse SVC and SVR models and Beckwith M-0067E voltage regulating relays.

It includes a replaceable voltage sensing fuse (with a spare fuse in the fuseholder). Replace the fuse with Cat.No. 312.300, Manufactured by LITTELFUSE, rated 250 VAC / 0.3 A only. Use of another fuse may present a risk of fire or explosion.

For further information on

- TAPCON®250
- Analog Input/Output Module
- Communication interface card
- Adapter Panels

please contact Reinhausen Manufacturing or www.tapcon250.com.

3 Commissioning

3.1 Installation

Mount the TAPCON® 250 voltage controller to the back of the Adapter Panel TC250-67 and secure it with the four provided screws. Insert the two plugs from the adapter panel into the connector at the bottom of the TAPCON® 250 and ensure their correct placement (see Figure 1).

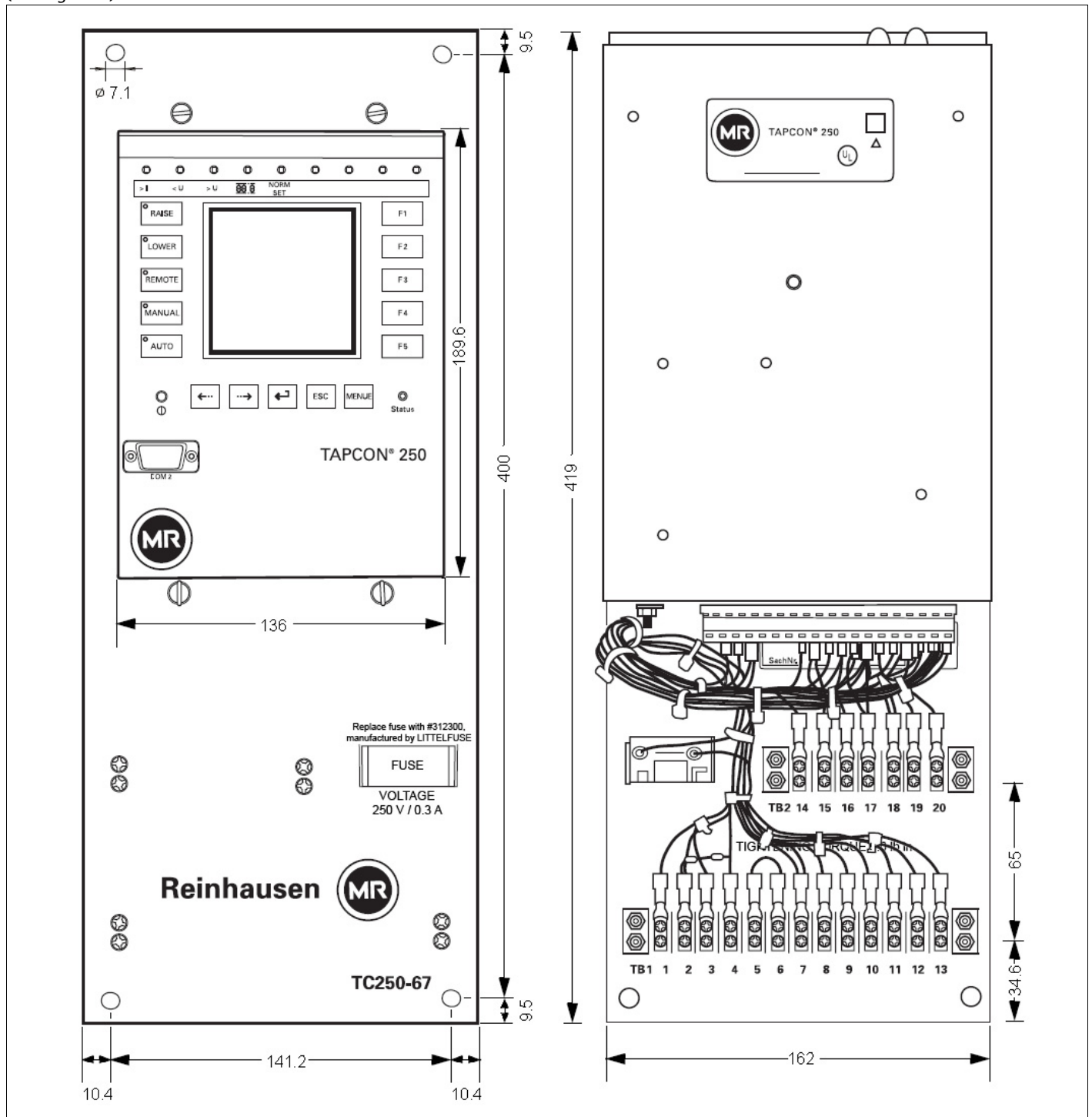

Figure 1 TC250-67 outline dimensions and rear view



Then install the Adapter Panel TC250-67 (with the TAPCON® 250) into the control cabinet or a corresponding mounting point.

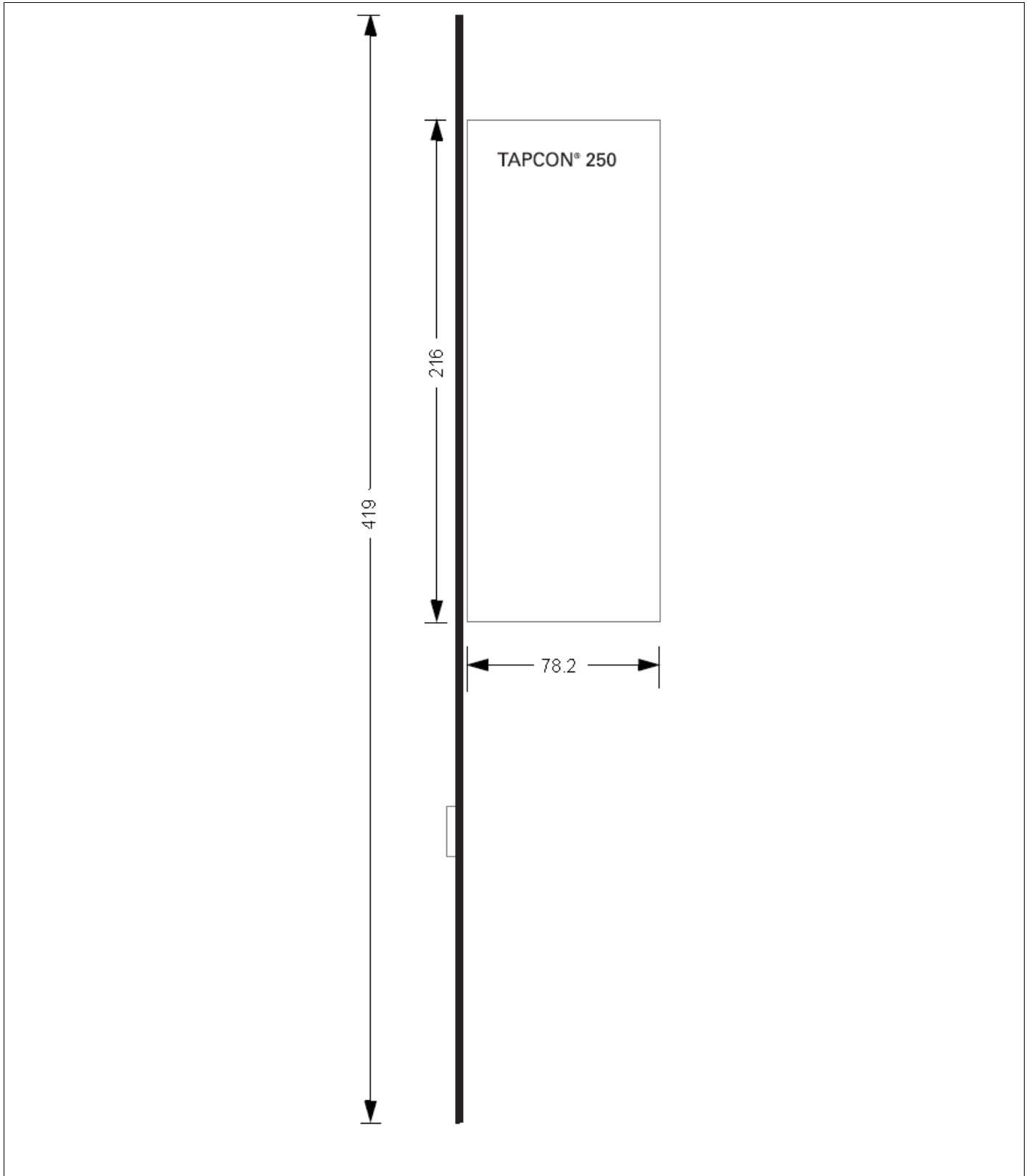

Figure 2 TC250-67 side view

TAPCON® 250 Adapter Panel TC250 - 67

3.2 Connection

Connect the adapter panel with the voltage controller in accordance with the wiring diagram (see Figure 3) and according to the wiring diagram of the respective motor drive. In general, the voltage controller is operated by the measurement voltage of 85...140 VAC on pin TB1.1 (Line) and pin TB1.3 (Neutral). The TB1 and TB2 terminal block connections should be made with a #16 - #22 AWG Copper wire in a TYCO/AMP 36150 type (or equivalent) ring tongue terminal and 9.0 lb in tightening torque.

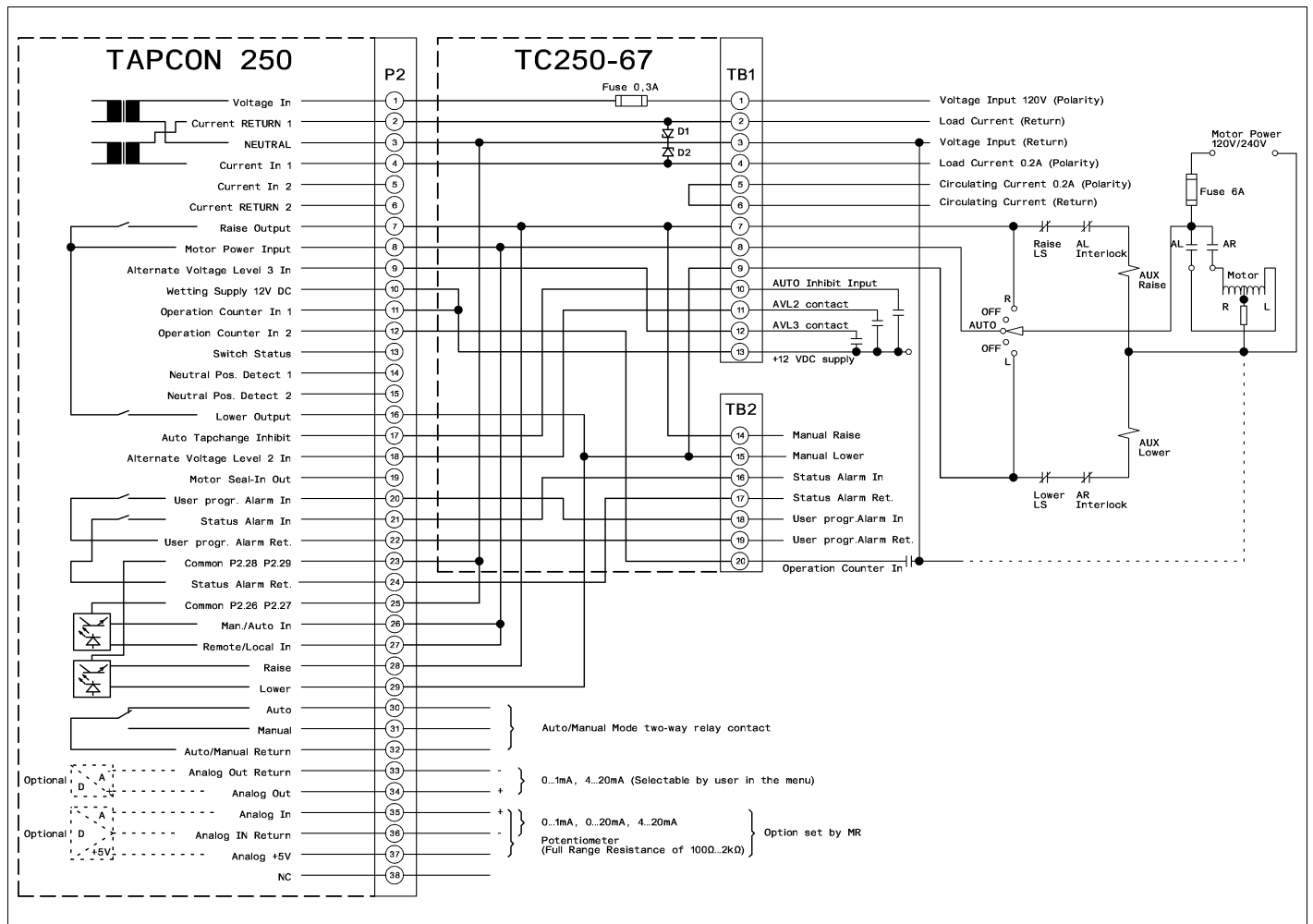
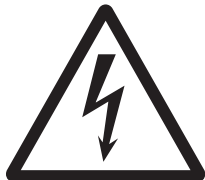

Figure 3 Wiring diagram

Notes

- 1) Motor voltage may be 120 or 240 V to neutral, or 240 V phase-to-phase.
- 2) A ground connection has to be provided to the CT/VT's neutral connection, external to the control.
- 3) An interconnection between NEUTRAL (TB2.3) and the Motor Power Return line is recommended.

	WARNING!
	<p>Risk of electric shock! Always short the current inputs before removing an auxiliary current transformer. Death or severe electrical shock may occur.</p>



The voltage controller alternatively accepts an external +12 VDC/1A power supply on terminal P3 (P3.1 = polarity, P3.2 = return) for continuous operation during an AC power outage. The TAPCON® 250 was developed in compliance with the relevant EMC standards. The following instructions must be observed to ensure preservation of the EMC properties:

- Ensure proper grounding of the TAPCON® 250 by means of the chassis ground screw attached to the housing.
- Be sure to use only shielded cables for the data links from the TAPCON® 250 to other equipment
- Refer to the Operating Instructions BA 297 provided separately for wiring details if needed

	WARNING!
	<p>Risk of electric shock! Ensure that the voltage controller is connected and the housing grounded with due care.</p>

	NOTE!
	<p>Pay attention to the correct phase angle of the secondary terminal of current transformer and voltage transformer. Ensure correct connection of the output relays to the motor-drive unit.</p>

3.3 External Connections

Pin TB1.1 Voltage Input

This input accepts nominal 120 VAC, 45...65 Hz to operate the control's power supply and voltage sensing input. The acceptable voltage range for proper control operation is 85-140 VAC. Power consumption is 6 VA to 12 VA depending on the amount of extensions. The input voltage is referenced to line neutral (Pin TB1.3).

Pin TB1.2 Load Current Return

This is the non-polarity input to the load current measuring transformer. The companion polarity input is Pin TB1.4. The line current transformer input is isolated from other pins.

Pin TB1.3 Neutral

This is the return for the Voltage Input (Pin TB1.1), and nominal +12 VDC "wetting" voltage (Pin TB1.13).

Pin TB1.4 Load Current Polarity

The line current input range is 0-420 mA (200 mA continuous) with 200 mA representing the 1.0 per unit value. The measured

current value is used for line drop compensation and metering calculation.

WARNING: The current input to the TAPCON® 250 is rated at 200 mA continuous, 420 mA for two hours, and 4.0 A for 1 second.

Pin TB1.5 Circulating Current Polarity

Bridged with pin TB1.6

Pin TB1.6 Circulating Current Return

Bridged with pin TB1.5

Pin TB1.7 Tap-Changer Raise Output

This switched output connects the tap-changer raise winding to the source of the motor power (Pin TB1.8). When the controller calls for a raise, it is capable of switching up to 6 A at 120/240 VAC.

Pin TB1.8 Motor Power Input

The source for powering the tap-changer motor (and thus for the raise and lower circuits) is connected here. It may have a maximum voltage of 240 VAC.

	NOTE!
	<p>This terminal is internally connected to the MANUAL/AUTO (P2.26) and LOCAL/REMOTE (P2.27) Pins of the TAPCON®250. As soon as motor-power is available at TB1.8 the controller will switch to automatic operation mode and to remote control mode (i.e. communication protocol commands will be possible).</p>

Pin TB1.9 Tap-Changer Lower Output

This switched output connects the tap-changer lower winding to the source of motor power. When the controller calls for a lower, it is capable of switching up to 6 A at 120/240 VAC.

Pin TB1.10 Auto Tap-Change Inhibit

Auto tap-change inhibit is invoked by closing and maintaining a contact connected to this input and to the nominal +12 VDC wetting source (Pin TB1.13). As long as this contact is closed, the tap-changer will not time out, thereby prohibiting raise and lower commands. After opening this contact all timers are reset and the controller starts with normal operation again except in case of a voltage level change (see operating instructions BA 297 for detailed information).

Pin TB1.11 Alternate Voltage Level #2

This digital input is typically enabled by connecting it to the nominal +12 VDC wetting source (Pin TB1.13) through an external

dry contact. The amount of alternate voltage implemented is determined by the setting in the Parameter => Regulation param. menu.

Pin TB1.12 Alternate Voltage Level #3

This digital input is typically enabled by connecting it to the nominal +12 VDC wetting source (Pin TB1.13), through an external dry contact. The amount of alternate voltage is determined by the setting in the Parameter => Regulation param. menu.

	NOTE!
	<p>Enabling both alternate voltage levels #2 and #3 inputs simultaneously will result in the level of alternate voltage as specified in the alternate voltage #4 setting in the Parameter => Regulation param. menu.</p>

Pin TB1.13 +12 V DC Wetting Voltage

This is the output of an unregulated DC power supply internal to the controller. It is referenced to neutral and can supply up to 100 mA. It is used for powering the digital inputs of the controller through external relays. Depending on the voltage supplied to Pin TB1.1 and loading, its output can vary from +10 to +18 V DC. It is not fused in the controller.

Pins TB2.14 & TB2.15 Manual Raise / Lower

These terminals provide a connection for external Raise and Lower switches for manual operation. Tap-change operations actuated by external switches will be recognized by the TAPCON®250 if the Raise and Lower Pins (TB1.7 and TB1.9) and the Operations Counter (TB2.20) are connected properly.

Pins TB2.16 & TB2.17 Self-Test Alarm

This pair of terminals is a held-open alarm relay contact rated for 6 A at 120 VAC. Failure of the power supply or the microcontroller results in loss of power to the alarm relay, allowing the contact to close.

Pins TB2.18 & TB2.19 User-Programmable Alarm

This pair of terminals is an alarm relay contact rated for 6 A at 120 VAC. This alarm closes when any of eight programmable alarm conditions are detected.

Pin TB2.20 Operations Counter

This digital input registers the counter contact closure. The operation counter will increment when Pin TB2.20 is grounded via the tap-changer dry contact

The input is level-sensitive. Make sure that any "wetting" voltages are removed from the counter contacts before installing the TC250-67 adapter panel (with TAPCON®250)

WARNING: +12 VDC or 120 VAC must not be applied to this terminal.

www.reinhausen.com/rm/en/
www.tapcon250.com

Reinhausen Manufacturing Inc.
2549 North 9th Avenue
Humboldt, Tennessee 38343, USA

Phone: (+1)731/784-7681
Fax: (+1)731/784-7682
E-Mail: reinhausen@bestltc.com

